

**barbecue®**

THE TASTE OF FUN



CATALOG 2023

Barbecue, the Belgian barbecue specialist, has had only one mission since its foundation in 1985:

# Using innovation to make barbecuing more fun, easier and simpler.

Today, Barbecue not only offers various barbecue models, ranging from charcoal and gas to smokers and fire pits, but also a wide range of accessories: from protective gloves to barbecue tools, smoke chips and lighting products.

Barbecue is an ode to the beautiful things in life, to being together, to long and enjoyable dinners, and especially to the enormous diversity of irresistible barbecue preparations. Whether in winter or summer, in the city or in the country, with friends, family or as a couple, Barbecue is the Belgian barbecue brand that brings people together. Barbecue, the taste of fun!

Follow us on social media or take a look at our new website:

 Barbecue
  Barbecue
  Barbecue

[www.barbecue.com](http://www.barbecue.com)

## In order to serve our customers even better,

we recently launched a completely new B2B website, [www.livwise.shop](http://www.livwise.shop). This new website makes it even easier to place orders. Moreover, in addition to our extensive range of products, it is also possible to order spare parts.

Looking for pictures, videos or manuals? They can all be downloaded via our website.

Create an account and enjoy the numerous advantages!

## Barbecue in your shop!

With our extensive range of POS material, you can put the Barbecue collection in the spotlight in your shop. Banners, columns, folders, displays... we have it all. Contact your representative to put together the ideal POS package for your store.

## Get inspired!

At [www.barbecue.com](http://www.barbecue.com) everybody can easily find extra information about our products. Those who buy a barbecue in your shop can register it here and find their replacement parts quickly and easily. We also offer a lot of extra barbecue tips & tricks and recipes.

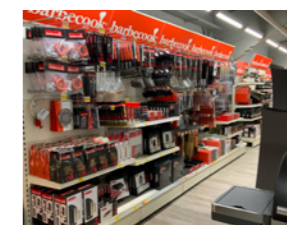
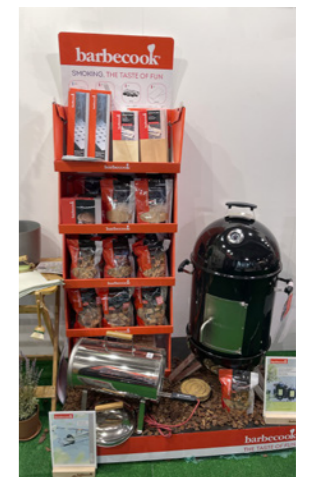

# BARBECOOK

## CHARCOAL

Magnus **NEW** p 8



Magnus Original



Magnus Comfort



Magnus Premium

Loewy p 14



Loewy 40



Loewy 45



Loewy 50



Loewy 50 SST



Loewy 55



Loewy 55 SST

Kamal p 18



Kamal Medium



Kamal Large



Kamal Large mat

Edson p 22



Edson Army Green



Edson Black

Carlo p 26



Carlo Urban Grey



Carlo Yellow Sunshine



Carlo Army Green



Carlo Chilli Pepper

Joya p 30



Joya

## GAS

Spring p 38



Spring 2002



Spring 3002



Spring 3112



Spring 3212

Siesta Graphite **NEW** p 42



Siesta 210 Graphite



Siesta 310 Graphite



Siesta 412 Graphite

Siesta p 46



Siesta 210 Black Edition



Siesta 310 Black Edition



Siesta 412 Black Edition



Siesta 612 Black Edition

Stella p 50



Stella 3201



Stella 3221



Stella 4311

Buddy p 54



Premium buddy for gas barbecue

## PLANCHA

Victor p 56



Victor plancha and trolley

## ELECTRIC

Alexia p 62



Alexia 5011



Alexia 5111

## SMOKERS

Otto 2.0 **NEW** p 70



Otto 2.0

Oskar p 74



Oskar S



Oskar M

## WOOD

Nestor **NEW** p 80



Nestor Original black



Nestor Original corten steel

Junko p 84



Junko

Rila p 88



Rila

Jack & Jill p 90



Jack 60



Jack 75



Jill

Firepit p 92



Classic Squadra



Jura



Modern Ronda



Modern 60



Modern 75



Sierra

## ACCESSORIES p 94



# MAGNUS

**NEW**



Magnus is 100% designed by Barbecue, easy to use and your barbecue partner for life thanks to its fun extra features. The art of indirect grilling will no longer hold any secrets for you. Thanks to the three separate grids, you can easily play with the two different height levels. The oval grill is ideal to create different heat zones. Low & slow is the way to go. With the handy integrated charcoal starter, you will be grilling in no time. Discover all the advantages of Magnus and it will become an indispensable member of your family.

CHARCOAL

Removable hinged lid with soft touch handle.

Perfect ergonomic cooking height (90cm).

Hasslefree grilling with stainless steel charcoal baskets.

Compatible with all Dynamic Core accessories for more cooking possibilities.

Flexible XL cast iron grids to serve up to 14 people.

Powder coated sidetables with stainless steel toolhooks.

1mm Enamelled steel fire box.

Easy start thanks to the Enamelled charcoal starter.

Extra wide base for maximum stability.

Heavy duty wheels for easy transport.



## MAGNUS ORIGINAL



## MAGNUS COMFORT



## MAGNUS PREMIUM



# MAGNUS

**MAGNUS ORIGINAL**  
BC-CHA-1067



**MAGNUS COMFORT**  
BC-CHA-1068



**MAGNUS PREMIUM**  
BC-CHA-1069



	MAGNUS ORIGINAL	MAGNUS COMFORT	MAGNUS PREMIUM
Number of persons	14	14	14
Dimensions l x w x h	85x64x110cm	85x64x110cm	85x64x110cm
Cooking height	90cm	90cm	90cm
Adjustable grids	✓ 2 positions	✓ 2 positions	✓ 2 positions
Cooking size	67 x 43 cm	67 x 43 cm	67 x 43 cm
Material grill	stainless steel 430	cast iron	cast iron
Material lid	enamelled steel	enamelled steel	enamelled steel
Material bowl	enamelled steel	enamelled steel	enamelled steel
Material feet	plastic	plastic	plastic
Material cart	heat resistant powder coating	heat resistant powder coating	heat resistant powder coating
Adjustable airsupply	✓	✓	✓
Ash container	✓	✓	✓
Lid with thermometer	✓	✓	✓
Fixed wheels	2	2	2
Accessory hooks		✓	✓
Charcoal starter		✓	✓
Number of side tables		1	2
Charcoal baskets			2

Item ean



5 404035 700754



5 404035 700761



5 404035 700778

## SUITABLE COVER



**MAGNUS ORIGINAL**  
BC-ACC-7174  
Premium barbecue cover



**MAGNUS COMFORT & PREMIUM**  
BC-ACC-7176  
Premium barbecue cover

## MAKE YOUR MAGNUS COMPLETE WITH THESE ACCESSORIES



BC-ACC-7451  
Pizza oven for Magnus



BC-ACC-7450  
Coal trays for Magnus



BC-ACC-7449  
Charcoal starter for Magnus



BC-ACC-7126  
Universal cooking griddle of enamelled cast iron



BC-ACC-7127  
Universal pizza stone made of refractory clay



BC-SMO-7422  
Cold smoker starter set



BC-ACC-7086  
Digital thermometer with app



BC-ACC-7051  
Olivia Premium cleaning brush with palm hair



BC-ACC-7113  
Bag of 72 lighter cubes FSC®



BC-ACC-7425  
Premium coconut briquettes 5kg



BC-ACC-7167  
Poultry roaster



BC-ACC-7083  
Grill mesh

# MAGNUS

**5**  
year  
warranty\*

Double ventilation

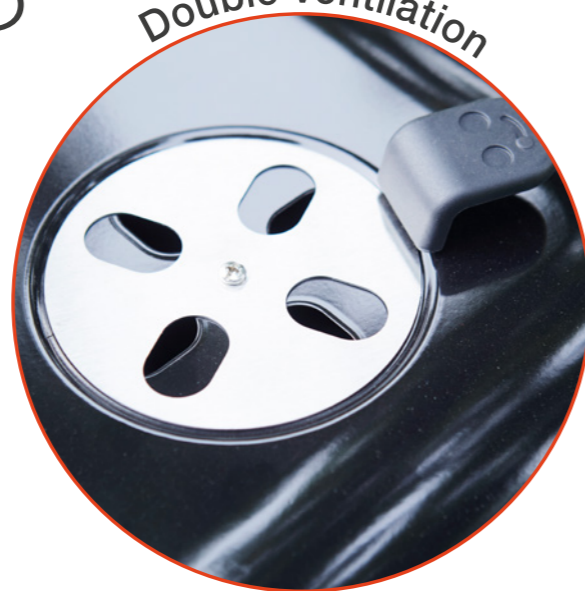

Removable lid



Cooking on different levels



**DYNAMIC CORE**



Air supply



Smoking options



Integrated ash container

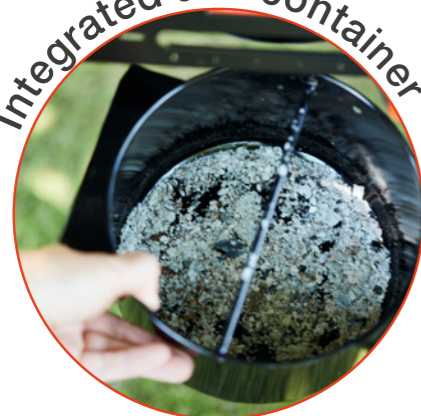

barbecue

barbecue

\* 5-year guarantee on lid and fire box (not rusted through, not burned through). 2 years on all other parts.

# LOEWY



Meet Loewy, the iconic charcoal barbecue executed in a streamlined design. Thanks to the Quick-Start® and QuickStop systems you can effortlessly create the most delicious grilled food in no time at all. To put it briefly: Loewy is your right-hand man at every barbecue!

CHARCOAL

Windshield included.

Stainless steel grid.

Intense or gentle grilling with the height-adjustable grill with 3 levels.

Solid brace for safety and accessories included.

Has a QuickStart® and QuickStop system.

Adjustable air supply for perfect control of the fire.

Ash container included.



## LOEWY 40



## LOEWY 45



## LOEWY 50



## LOEWY 50 SST



## LOEWY 55



## LOEWY 55 SST





# LOEWY

**LOEWY 40** BC-CHA-1006    **LOEWY 45** BC-CHA-1007    **LOEWY 50** BC-CHA-1008    **LOEWY 50 SST** BC-CHA-1005    **LOEWY 55** BC-CHA-1009    **LOEWY 55 SST** BC-CHA-1004



Number of persons	4	6	10	10	10	10
Dimensions l x w x h	40x40x75 cm	43x43x97 cm	51,5x56x99 cm	51,5x56x99 cm	59,8x35,4x101 cm	59,8x35,4x101 cm
Cooking height	64-68-72 cm	84-87-91 cm	86-90-94 cm	86-90-94 cm	88-92-96 cm	88-92-96 cm
Adjustable grids	✓ 3 positions	✓ 3 positions	✓ 3 positions	✓ 3 positions	✓ 3 positions	✓ 3 positions
Cooking size	Ø 40 cm	Ø 43 cm	Ø 47.5 cm	Ø 47.5 cm	55 x 33 cm	55 x 33 cm
Material grill	stainless steel	stainless steel	stainless steel	stainless steel	stainless steel	stainless steel
Material bowl	enamelled steel	enamelled steel	enamelled steel	stainless steel	enamelled steel	stainless steel
Material tube	enamelled steel	enamelled steel	enamelled steel	stainless steel	enamelled steel	stainless steel
Material feet	enamelled steel	enamelled steel	enamelled steel	stainless steel	enamelled steel	stainless steel
Material windscreen	enamelled steel	enamelled steel	enamelled steel	stainless steel	enamelled steel	stainless steel
Adjustable airsupply	✓	✓	✓	✓	✓	✓
Ash container		✓	✓	✓	✓	✓
Quickstart® Lighting system	✓	✓	✓	✓	✓	✓
Quickstop system		✓	✓	✓	✓	✓
Quantity per pallet	32	16	16	16	16	16

Item ean



## SUITABLE COVER



BC-ACC-7170  
Premium barbecue cover



BC-ACC-7179  
Charcoal barbecue transparent cover

## MAKE YOUR LOEWY COMPLETE WITH THESE ACCESSORIES



BC-ACC-7426  
Wood wool firelighters  
32 pieces FSC®



BC-ACC-7421  
Premium charcoal  
FSC® 6kg



BC-ACC-7222  
Set of 40 long matches



BC-ACC-7024  
Black Pepper BBQ set with fork, tongs and turner



BC-ACC-7030  
Charcoal barbecue dome Loewy 45



BC-ACC-7032  
Charcoal barbecue dome Loewy 50



BC-ACC-7050  
Plastic floor mat black



BC-ACC-7216  
Grill cleaner



BC-ACC-7164  
Spit with 2 forks with motor for charcoal barbecue



BC-ACC-7087  
Cooking griddle for charcoal barbecue



BC-ACC-7013  
Universal pizza stone made of refractory clay



BC-ACC-7438  
Set of 2 Premium grill matt black Ø 32cm

## QUICKSTART®

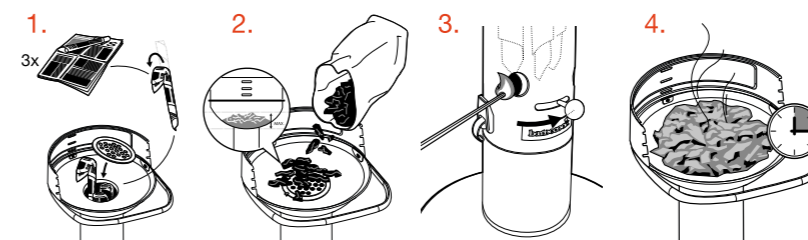

## QUICKSTOP

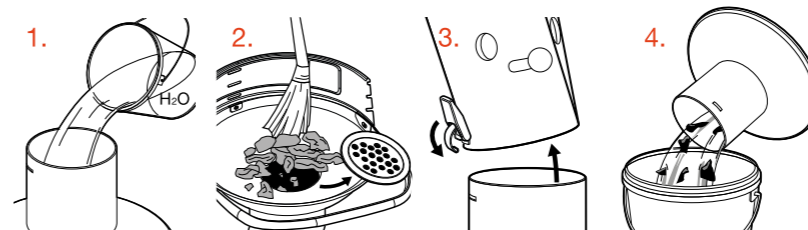

# KAMAL



Grilling, smoking, steaming, roasting... you can do it all with the kamado! The ceramic bowl and lid based on mullite allow you to keep the temperature more stable and the coals stay hot for a longer time. This makes it ideal to try slow-cooked ribs or pulled pork and enjoy the ultimate barbecue flavour.

In addition, this kamado has a lid with a 100% airtight seal and four solid springs, so that the smoke and the flavours stay inside. With the handy air supply, you can easily regulate the temperature yourself and remain master of the fire.

Ceramic based on mullite: wear-resistant and strong material, little heat conduction.

Air vent in cast aluminium.

Heat shield for indirect grilling.

Extra good closure due to flexible and durable seal.

High quality charcoal basket and ash container in stainless steel.



## KAMAL MEDIUM



## KAMAL LARGE



## KAMAL LARGE MAT



# KAMAL

**KAMAL MEDIUM**  
BC-CHA-1060



**KAMAL LARGE**  
BC-CHA-1061



**KAMAL LARGE MAT**  
BC-CHA-1062



	KAMAL MEDIUM	KAMAL LARGE	KAMAL LARGE MAT
Number of persons	8	12	12
Dimensions l x w x h	131 x 78 x 115,5 cm	138 x 84 x 110,5 cm	138 x 84 x 110,5 cm
Cooking height	82.5 cm	80 cm	80 cm
Cooking size	Ø 46 cm	Ø 53 cm	Ø 53 cm
Material grill	stainless steel	stainless steel	stainless steel
Material lid	ceramic (Mullite)	ceramic (Mullite)	ceramic (Mullite)
Material bowl	ceramic (Mullite)	ceramic (Mullite)	ceramic (Mullite)
Adjustable airsupply	✓	✓	✓
Ash container	✓	✓	✓
Lid with thermometer	✓	✓	✓
Casters	4	4	4
Quantity per pallet	3	3	3

Item ean



- 6 mm stainless steel grill with coal hatch
- Grill grids are dishwasher safe



- Lid with 4 springs
- Modern design

## SUITABLE COVER



BC-ACC-7445  
Premium cover for  
Kamal

## MAKE YOUR KAMAL COMPLETE WITH THESE ACCESSORIES



BC-ACC-7440  
Kamal Medium flexi-  
ble cooking system



BC-ACC-7441  
Kamal Large flexible  
cooking system



BC-ACC-7442  
Kamal Medium set of  
2 half-moon cast iron  
grids



BC-ACC-7443  
Kamal Large set of 2  
half-moon cast iron  
grids



BC-ACC-7052  
Premium pair of  
gloves black



BC-ACC-7305  
Bamboo cutting board  
with groove FSC®  
46.5x28x2.8cm



BC-ACC-7211  
Stainless steel  
saucepot with brush  
23x7.5x10.5cm



BC-ACC-7420  
Cast iron grill pan with  
bamboo trivet



BC-ACC-7015  
Meat and rib rack



BC-ACC-7086  
Digital thermometer  
with app



BC-ACC-7217  
Fire spices 250g



BC-WOO-6007  
Junko cast iron Dutch  
Oven 9L



- Integrated thermometer in °C and °F
- 2 foldable side tables
- Perfect temperature control thanks to built-in air regulator and top valve
- Includes base with sturdy castors and 2 brakes



- Ashtray and charcoal basket included

# EDSON



Edson is an eye-catcher at every party! This multi-functional drum can be converted from a barbecue to a party table in no time at all. Ideal to enjoy a drink before or after your barbecue party.

CHARCOAL



## EDSON BLACK



## EDSON ARMY GREEN



# EDSON

**EDSON BLACK**  
BC-CHA-1020

**EDSON ARMY GREEN**  
BC-CHA-1022



Number of persons	10	10
Dimensions l x w x h	60x60x90 cm	60x60x90 cm
Cooking height	89 cm	89 cm
Adjustable grids	✓ 2 positions	✓ 2 positions
Cooking size	Ø 47.5 cm	Ø 47.5 cm
Material grill	stainless steel	stainless steel
Material lid	galvanised steel	galvanised steel
Material bowl	enamelled steel	enamelled steel
Ash container	✓	✓
Quantity per pallet	2	2

Item ean



## SUITABLE COVER



BC-ACC-7414  
Premium cover for  
Edson

## MAKE YOUR EDSON COMPLETE WITH THESE ACCESSORIES



BC-ACC-7413  
Charcoal starter with  
safe drop stainless  
steel



BC-ACC-7026  
Army Style turner



BC-ACC-7027  
Army Style clean-  
ing brush with dual  
function



BC-ACC-7028  
Army Style tongs



BC-ACC-7109  
Leather apron brown



BC-ACC-7438  
Set of 2 Premium grill  
matt black Ø 32cm



# CARLO



Enjoy the great outdoors with friends and barbecue wherever you like: in the park, at the beach or even just on your balcony. Since Carlo is very compact, you can take him everywhere with you in his handy carrying bag.

Carlo remains "cool" on the outside, and gets really hot on the inside. Thanks to its unique design, you can grill without smoke and the ventilator allows you maximum control.

Carrying bag included.

Easy to use as a table barbecue.

Grill with raised edge.



Ventilator for constant and adjustable flame (excl 4 x AA batteries).

All components are dishwasher safe (except bowl with ventilator).

## CARLO URBAN GREY



## CARLO YELLOW SUNSHINE



## CARLO ARMY GREEN

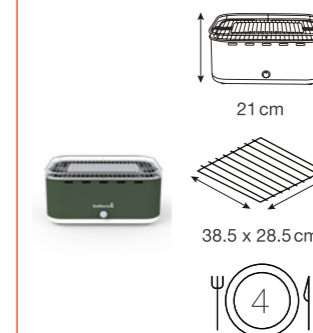

## CARLO CHILLI PEPPER

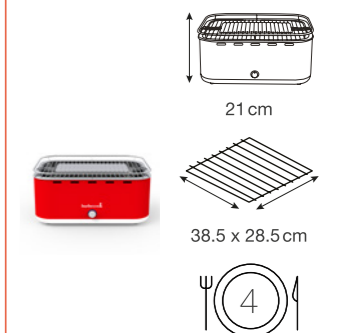

# CARLO

**CARLO URBAN GREY**  
BC-CHA-1015



**CARLO YELLOW SUNSHINE**  
BC-CHA-1016



**CARLO ARMY GREEN**  
BC-CHA-1018



**CARLO CHILLI PEPPER**  
BC-CHA-1019



Number of persons	4	4	4	4
Dimensions l x w x h	44x33x21 cm	44x33x21 cm	44x33x21 cm	44x33x21 cm
Cooking height	21 cm	21 cm	21 cm	21 cm
Cooking size	38.5 x 28.5 cm	38.5 x 28.5 cm	38.5 x 28.5 cm	38.5 x 28.5 cm
Material grill	stainless steel	stainless steel	stainless steel	stainless steel
Adjustable airsupply	✓	✓	✓	✓
Quantity per pallet	35	35	35	35

Item ean



## SUITABLE COVER INCLUDED



## MAKE YOUR CARLO COMPLETE WITH THESE ACCESSORIES



BC-ACC-7426  
Wood wool firelighters  
32 pieces FSC®



BC-ACC-7425  
Premium coconut  
briquettes 5kg



BC-ACC-7073  
Set of 10 stainless  
steel skewers



BC-ACC-7419  
Stainless steel sau-  
sage tongs



BC-ACC-7078  
Digital pocket ther-  
mometer



BC-ACC-7064  
3-in-1 brush red



# JOYA



With the Joya table barbecue you can enjoy a whole evening with the family at the table, without someone standing alone to man the barbecue. Everyone simply cooks his or her own favourite dish!

CHARCOAL

Grill grid of stainless steel.

Including plancha plate from stainless steel.

Including 4 tongs made of stainless steel.

Grill grid and plancha plate are dishwasher safe.



Thanks to the double ceramic wall, Joya remains cool on the outside.

3 feet for stability.

JOYA

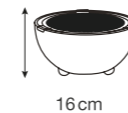

16 cm



Ø 31 cm





# JOYA

**JOYA**  
BC-CHA-1066



Number of persons	4
Dimensions l x w x h	31 x 31 x 16 cm
Cooking size	Ø 31 cm
Material grill	stainless steel
Material bowl	stainless steel
Quantity per pallet	48

Item ean



## MAKE YOUR JOYA COMPLETE WITH THESE ACCESSORIES



BC-ACC-7117  
Lighting gel 1L



BC-ACC-7425  
Premium coconut  
briquettes 5kg



BC-ACC-7092  
Silicone brush



BC-ACC-7220  
Mini hamburger press  
for 3 burgers



BC-ACC-7118  
Joya rubber wood  
rotating table with 6  
bowls



BC-ACC-7051  
Olivia Premium  
cleaning brush with  
palm hair

## HOW TO USE YOUR JOYA?





# DYNAMIC CORE

The gas barbecues Siesta and Stella and the charcoal barbecue Magnus feature a Dynamic Core: the barbecue's central and hottest space, designed in such a way that it allows you to easily remove from the grill. This means you can push your limits and that of your barbecue by replacing the grill with accessories such as a pizza stone, a griddle or the Dynamic Core grill. These will give you even more possibilities and you will grow into a genuine Barbecue virtuoso!

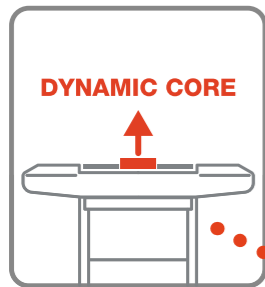

BC-ACC-7126



BC-ACC-7127



Add smoke flavour to your dish  
BC-SMO-5019



# SPRING



Thanks to Spring, your very first gas barbecuing experience will be perfect: all the benefits of Barbecue convenience in combination with its simple features. The durable cast-iron grills retains heat better, while giving the food you prepare those typical, appetizing-looking stripes. Spring is the perfect start to a new chapter in your barbecue life.

Enamelled lid with thermometer.

Can be combined with the rotisserie set.

Keep food warm on the special rack.

Enamelled cast-iron grills.

1 fixed side table.

Side burner included.

Easy and safe electronic ignition (excl 1 AA battery).

Drip pot included (dishwasher safe).

Cart with door + storage space.

Easy to move around due to the large wheels.



## SPRING 2002

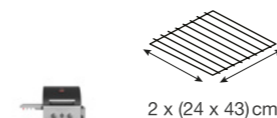
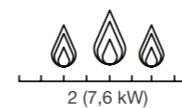

## SPRING 3002

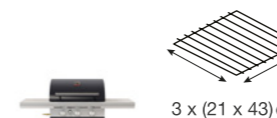
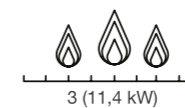

## SPRING 3112

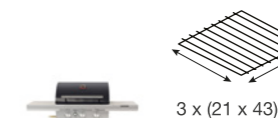
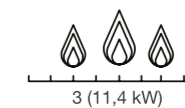

## SPRING 3212

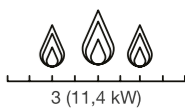

# SPRING

**SPRING 2002**  
BC-GAS-2009

**SPRING 3002**  
BC-GAS-2000

**SPRING 3112**  
BC-GAS-2002

**SPRING 3212**  
BC-GAS-2003



	8	10	10	10
Number of persons	8	10	10	10
Dimensions l x w x h	111x55x115 cm	133x57x115 cm	133x57x115 cm	133x57x115 cm
Cooking height	90 cm	91 cm	91 cm	91 cm
Cooking size	2 x (24 x 43) cm	3 x (21 x 43) cm	3 x (21 x 43) cm	3 x (21 x 43) cm
Material grill	enamelled cast iron	enamelled cast iron	enamelled cast iron	enamelled cast iron
Material lid	enamelled steel	enamelled steel	enamelled steel	enamelled steel
Material bowl	enamelled steel	enamelled steel	enamelled steel	enamelled steel
Material cart	lacquered steel	lacquered steel	lacquered steel	lacquered steel
Number of main burners	2	3	3	3
Total power main burners	7,6 kW	11,4 kW	11,4 kW	11,4 kW
Number of side burners				1
Power side burners				2,3 kW
Storage space			✓	✓
Lid with thermometer	✓	✓	✓	✓
Fat drainage	✓	✓	✓	✓
Fixed wheels	2	2	2	2
Accessory hooks	✓			
Quantity per pallet	3	4	4	4

Item ean



## SUITABLE COVER



**SPRING 2002**  
BC-ACC-7174  
Premium barbecue cover



**SPRING 3002/3112/ 3212**  
BC-ACC-7172  
Premium barbecue cover

## MAKE YOUR SPRING COMPLETE WITH THESE ACCESSORIES

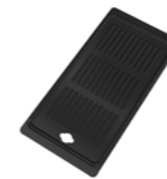

BC-SPA-8662  
Cast iron griddle



BC-ACC-7166  
Set for gas barbecue with 2 spit forks



BC-ACC-7050  
Plastic floor mat black



BC-ACC-7213  
Set of 10 oven and barbecue bags



BC-ACC-7211  
Stainless steel saucepot with brush 23x7.5x10.5cm



BC-ACC-7350  
Bamboo box for barbecue tools FSC®

## GAS REGULATORS



BC-ACC-7190  
Gas regulator Italy and Greece with hose 30mbar



BC-ACC-7188  
Gas regulator France with hose 37mbar



BC-ACC-7184  
Gas regulator The Netherlands with hose 30mbar



BC-ACC-7186  
Gas regulator Belgium and Luxembourg with hose 37mbar

Gas regulator is not included with the gas barbecues. This differs per country and type of gas bottle.

# SIESTA GRAPHITE

**NEW**



With these Siesta Graphite gas barbecues, you get the well-known Siesta quality and grilling comfort, but with a new stylish look. The Siesta gas barbecues takes your barbecue experience to a whole new level. Don't worry about the clean up afterwards. The drip trays will catch most of the grease and can go into the dishwasher. This gives you more time to enjoy your barbecue triumphs.

GAS



## SIESTA 210 GRAPHITE



## SIESTA 310 GRAPHITE



## SIESTA 412 GRAPHITE

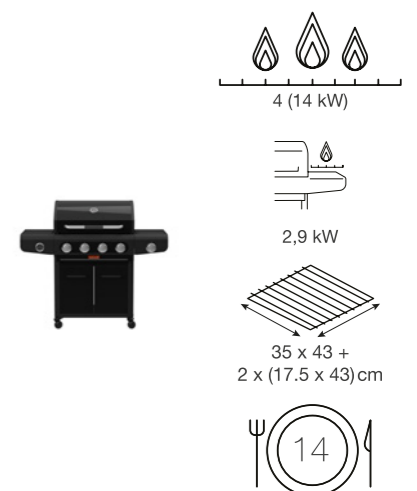

# SIESTA GRAPHITE

**SIESTA 210 GRAPHITE**  
BC-GAS-2071



**SIESTA 310 GRAPHITE**  
BC-GAS-2072



**SIESTA 412 GRAPHITE**  
BC-GAS-2073



Number of persons	8	12	14
Dimensions l x w x h	112x56x118cm	124x56x118cm	132x56x118cm
Cooking height	93cm	93cm	93cm
Cooking size	35 x 43 + 13.5 x 43cm	35 x 43 + 2 x (13.5 x 43)cm	35 x 43 + 2 x (17.5 x 43)cm
Material grill	enamelled cast iron	enamelled cast iron	enamelled cast iron
Material lid	enamelled steel	enamelled steel	enamelled steel
Material bowl	enamelled steel	enamelled steel	enamelled steel
Material cart	lacquered steel	lacquered steel	lacquered steel
Number of main burners	2	3	4
Total power main burners	8 kW	12 kW	14 kW
Number of side burners	1	1	1
Power side burners	2,9 kW	2,9 kW	2,9 kW
Storage space			✓
Lid with thermometer	✓	✓	✓
Fat drainage	✓	✓	✓
Fixed wheels	2	2	
Casters			4
Accessory hooks	✓	✓	✓

Item ean



5 404035 700822



5 404035 700839



5 404035 700846

## SUITABLE COVER



**SIESTA GRAPHITE 210**  
BC-ACC-7176  
Premium barbecue cover



**SIESTA GRAPHITE 310 & 412**  
BC-ACC-7172  
Premium barbecue cover

## MAKE YOUR SIESTA GRAPHITE COMPLETE WITH THESE ACCESSORIES



BC-ACC-7015  
Meat and rib rack



BC-SMO-5019  
Smoker box



BC-ACC-7033  
Olivia stainless steel  
spatula



BC-ACC-7037  
Olivia stainless steel  
fork



BC-ACC-7163  
Siesta universal spit  
black with 2 forks



BC-ACC-7127  
Universal pizza stone  
made of refractory  
clay

## GAS REGULATORS



BC-ACC-7190  
Gas regulator Italy  
and Greece with hose  
30mbar



BC-ACC-7188  
Gas regulator France  
with hose 37mbar



BC-ACC-7184  
Gas regulator The  
Netherlands with  
hose 30mbar



BC-ACC-7186  
Gas regulator Belgium  
and Luxembourg with  
hose 37mbar

Gas regulator is not included with the gas barbecues. This differs per country and type of gas bottle.

# SIESTA



The Siesta gas barbecues takes your barbecue experience to a whole new level. Don't worry about the clean up afterwards. The drip trays will catch most of the grease and can go into the dishwasher. This gives you more time to enjoy your barbecue triumphs.

GAS

Durable repellent glass finish.

Double-walled lid for a constant temperature.

Can be combined with the rotisserie set.

Enamelled cast-iron grills.  
1 fixed side table.

Drip tray included (dishwasher safe).

Integrated bottle opener.

Cabinet with doors with storage space and external gas cylinder holder.

Easy to move around due to wheels.

Enamelled lid with thermometer.

Dynamic Core plancha tray included.

Keep food warm on the special rack.

With spit burner (38 kW).

Side burner included.

Automatic ignition in control button.

Integrated waste bin and bottle rack.



## SIESTA 210 BLACK EDITION

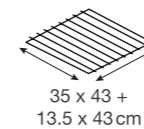
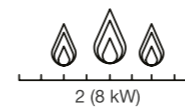

## SIESTA 310 BLACK EDITION

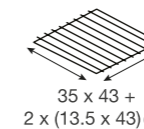
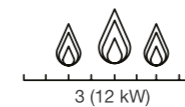

## SIESTA 412 BLACK EDITION

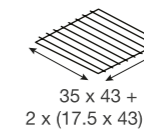
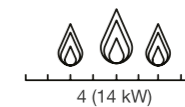

## SIESTA 612 BLACK EDITION

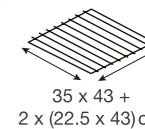
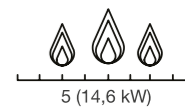



# SIESTA

**SIESTA 210 BLACK EDITION**  
BC-GAS-2014



**SIESTA 310 BLACK EDITION**  
BC-GAS-2018



**SIESTA 412 BLACK EDITION**  
BC-GAS-2024



**SIESTA 612 BLACK EDITION**  
BC-GAS-2031



	8	12	14	16
Number of persons	8	12	14	16
Dimensions l x w x h	112x56x118 cm	124x55,7x118,8 cm	132x55,7x118,8 cm	143x56x120 cm
Cooking height	93 cm	93 cm	93 cm	93 cm
Cooking size	35 x 43 + 13.5 x 43 cm	35 x 43 + 2 x (13.5 x 43) cm	35 x 43 + 2 x (17.5 x 43) cm	35 x 43 + 2 x (22.5 x 43) cm
Material grill	enamelled cast iron	enamelled cast iron	enamelled cast iron	enamelled cast iron
Material lid	enamelled steel	enamelled steel	enamelled steel	enamelled steel
Material bowl	enamelled steel	enamelled steel	enamelled steel	enamelled steel
Material cart	lacquered steel	lacquered steel	lacquered steel	lacquered steel
Number of main burners	2	3	4	5
Total power main burners	8 kW	12 kW	14 kW	14,6 kW
Number of side burners	1	1	1	1
Power side burners	2,9 kW	2,9 kW	2,9 kW	2,9 kW
Number of spit burners				1
Storage space			✓	✓
Lid with thermometer	✓	✓	✓	✓
Fat drainage	✓	✓	✓	✓
Fixed wheels	2	2		
Casters			4	4
Accessory hooks	✓	✓	✓	✓
Quantity per pallet	4	4	4	4

Item ean



## SUITABLE COVER



**SIESTA 210**  
BC-ACC-7176  
Premium barbecue cover



**SIESTA 310/412/ 612**  
BC-ACC-7172  
Premium barbecue cover

## MAKE YOUR SIESTA COMPLETE WITH THESE ACCESSORIES



BC-ACC-7017  
Brochette holder



BC-ACC-7439  
Set of 2 Premium grill  
matt black 40x33cm



BC-ACC-7045  
Olivia stainless steel  
universal gripper



BC-ACC-7038  
Olivia stainless steel  
marinade brush



BC-ACC-7033  
Olivia stainless steel  
spatula



BC-ACC-7163  
Siesta universal spit  
black with 2 forks

## GAS REGULATORS



BC-ACC-7190  
Gas regulator Italy  
and Greece with hose  
30mbar



BC-ACC-7188  
Gas regulator France  
with hose 37mbar



BC-ACC-7184  
Gas regulator The  
Netherlands with  
hose 30mbar



BC-ACC-7186  
Gas regulator Belgium  
and Luxembourg with  
hose 37mbar

Gas regulator is not included with the gas barbecues. This differs per country and type of gas bottle.

# STELLA



The convenience of bringing your kitchen into the garden. Isn't that something everyone wants? Powerful burners that give you complete control over the cooking process, or drawers with plenty of storage space for your cooking utensils? Stella transforms your garden into a second kitchen. Stella has an eye for detail and combines high-quality features with robust design.

GAS



## STELLA 3201

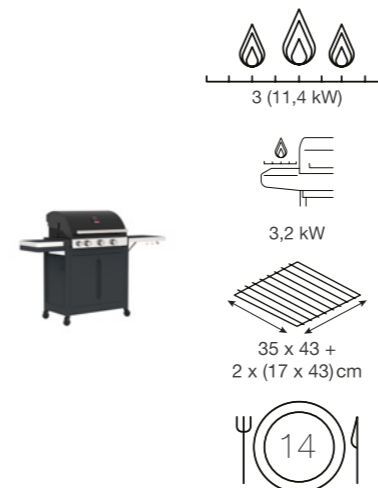

## STELLA 3221



## STELLA 4311

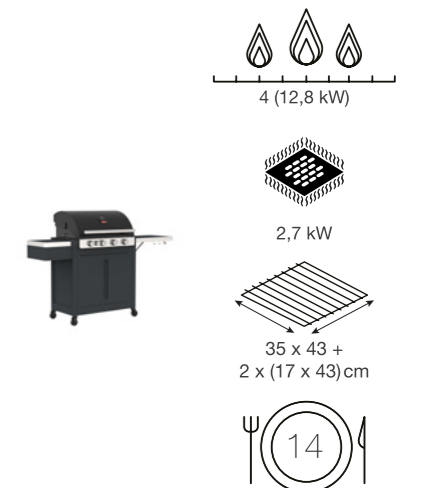

# STELLA

**STELLA 3201**  
BC-GAS-2036

**STELLA 3221**  
BC-GAS-2037

**STELLA 4311**  
BC-GAS-2038



Number of persons	14	14	14
Dimensions l x w x h	174x59x119cm	174x59x119cm	174x59x119cm
Cooking height	99cm	99cm	99cm
Cooking size	35 x 43 + 2 x (17 x 43)cm	35 x 43 + 2 x (17 x 43)cm	35 x 43 + 2 x (17 x 43)cm
Material grill	enamelled cast iron	enamelled cast iron	enamelled cast iron
Material lid	enamelled steel	enamelled steel	enamelled steel
Material bowl	enamelled steel	enamelled steel	enamelled steel
Material cart	enamelled steel	enamelled steel	enamelled steel
Number of main burners	3	3	4
Total power main burners	11,4 kW	11,4 kW	12,8 kW
Number of side burners	1	1	1
Power side burners	3,2 kW	3,2 kW	2,7 kW
Storage space	✓	✓	✓
Lid with thermometer	✓	✓	✓
Fat drainage	✓	✓	✓
Dynamic core plancha included		✓	✓
Casters	4	4	4
Accessory hooks	✓	✓	✓
Quantity per pallet	3	2	3

Item ean



## SUITABLE COVER



BC-ACC-7172  
Premium barbecue  
cover

## MAKE YOUR STELLA COMPLETE WITH THESE ACCESSORIES



BC-SMO-5019  
Smoker box



BC-ACC-7024  
Black Pepper BBQ  
set with fork, tongs  
and turner

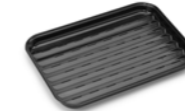

BC-ACC-7080  
Reusable enamel grill  
pan



BC-ACC-7221  
Hasselback potato  
prep set



BC-ACC-7086  
Digital thermometer  
with app



BC-ACC-7165  
Set for gas barbecue  
with 2 spit forks

## GAS REGULATORS



BC-ACC-7190  
Gas regulator Italy  
and Greece with hose  
30mbar



BC-ACC-7188  
Gas regulator France  
with hose 37mbar



BC-ACC-7184  
Gas regulator The  
Netherlands with  
hose 30mbar



BC-ACC-7186  
Gas regulator Belgium  
and Luxembourg with  
hose 37mbar

Gas regulator is not included with the gas barbecues. This differs per country and type of gas bottle.

# BUDDY



Add the Buddy to your barbecue and create your own outdoor kitchen. With the extra worktop, you have space to prepare your barbecue party outside and to present everything buffet-style. Afterwards, you can simply store all your tools in the large storage cupboard. This way, you will have everything ready at hand for your next barbecue.

GAS

Stainless steel worktop with raised edge.

Integrated bottle opener.

Inner dimensions: (l x w x h):  
72 x 40 x 50 cm.

Storage shelf inside.

Sturdy swivel castors with brake.



## MAKE YOUR BUDDY COMPLETE WITH THESE ACCESSORIES

### PREMIUM BUDDY BC-GAS-2070



Dimensions l x w x h	84 x 46 x 84 cm
Material cart	lacquered steel
Material tray	stainless steel
Storage space	✓
Castors	4
Quantity per pallet	5

Item ean



5 420059 859445



BC-ACC-7301  
Bamboo cutting board FSC®  
40x30x1.5cm



BC-ACC-7350  
Bamboo box for barbecue tools FSC®



BC-ACC-7094  
3-Piece standard set FSC®



BC-ACC-7420  
Cast iron grill pan with bamboo trivet



BC-ACC-7215  
Marinade injector

# PLANCHA VICTOR



Victor will help you fully enjoy your plancha moment, so that you can focus on what is truly important. You can get started immediately and there is no lengthy clean up afterwards. With Victor around you'll save time!  
The light-weight cooking part has an attractive, streamlined design. Combined with the Thermicore plancha tray Victor guarantees higher energy efficiency: reduced energy consumption with the same results.

Thermicore plancha finished with non-stick coating (max 270°C).

Plate can be used on any stove, oven and gas bbq.

Easy heat-up system with minimal energy consumption.

Victor and trolley also available separately.

Robust trolley with large wheels for maximum comfort.

Attractive and durable design.



## THERMICORE PLANCHA

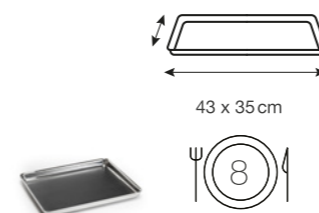

## VICTOR PLANCHA

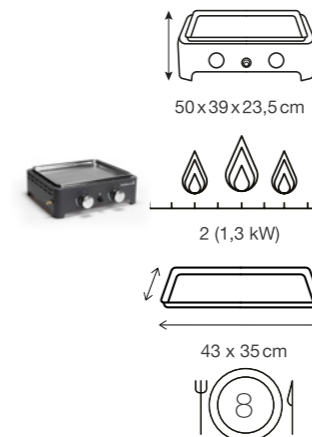

## VICTOR TROLLEY

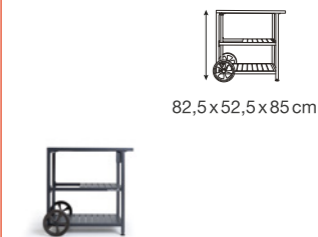

## VICTOR PLANCHA AND TROLLEY

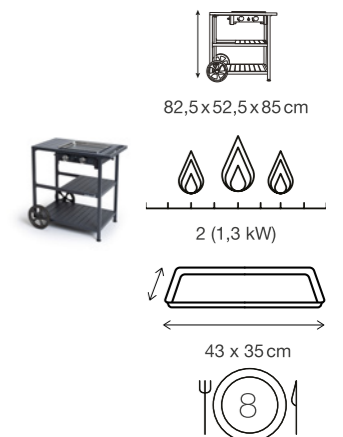

# VICTOR

**THERMICOORE  
PLANCHA**  
BC-PLA-3006



**VICTOR PLANCHA**  
BC-PLA-3007



**VICTOR TROLLEY**  
BC-PLA-3008



**VICTOR PLANCHA  
AND TROLLEY**  
BC-PLA-3009



Number of persons	8	8		8
Dimensions l x w x h	43x35x3,3cm	50x39x23,5cm	82,5x52,5x85cm	82,5x52,5x85cm
Cooking size	43 x 35cm	43 x 35cm		43 x 35cm
Material grill	thermicore	thermicore		thermicore
Material bowl		galvanised steel		galvanised steel
Material tray		stainless steel		stainless steel
Number of main burners		2		2
Total power main burners		2,6 kW		2,6 kW
Storage space			✓	✓
Fixed wheels			2	2
Quantity per pallet	136	28	18	4

Item ean



## MAKE YOUR VICTOR COMPLETE WITH THESE ACCESSORIES



BC-ACC-7012  
Nylon anti-scratch  
plancha spatula red



BC-ACC-7129  
Olivia stainless steel  
plancha dome  
Ø 30cm



BC-ACC-7220  
Mini hamburger press  
for 3 burgers



BC-ACC-7301  
Bamboo cutting  
board FSC®  
40x30x1.5cm



BC-ACC-7410  
Mineral oil for main-  
tenance bamboo  
& wooden boards  
200ml



BC-ACC-7092  
Silicone brush

## GAS REGULATORS



BC-ACC-7190  
Gas regulator Italy  
and Greece with hose  
30mbar



BC-ACC-7188  
Gas regulator France  
with hose 37mbar



BC-ACC-7184  
Gas regulator The  
Netherlands with  
hose 30mbar



BC-ACC-7186  
Gas regulator Belgium  
and Luxembourg with  
hose 37mbar



Gas regulator is not included with the gas barbecues. This differs per country and type of gas bottle.



# ALEXIA



barbecook

Are you looking for an ecological alternative to charcoal or gas, or just don't have a lot of space? This electric barbecue, Alexia, turns grilling into child's play, even in smaller spaces like a balcony, a city garden or indoors. Because you can remove the top part, Alexia can also easily be used on top of your yard table. This means your barbecue is within easy reach while you enjoy a cool cocktail. Is convenience important to you while grilling? Meet your new best friend: Alexia!

ELECTRIC

Non-stick coating on the grilling surface (without PFOA).

Griddle in poured aluminium with integrated resistance.

5 adjustable heat levels.

2 large wheels for easy movement.



Side table with accessory hooks.

Convenient extra plate at the bottom of the barbecue.

## ALEXIA 5011



97 cm



220-240 V  
1680-2000 W  
Europlug CEE 7/7

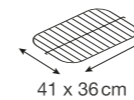

41 x 36 cm



## ALEXIA 5111



97 cm



220-240 V  
1680-2000 W  
Europlug CEE 7/7

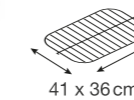

41 x 36 cm





# ALEXIA

**ALEXIA 5011**  
BC-ELE-4000



**ALEXIA 5111**  
BC-ELE-4001



Number of persons	4	4
Dimensions l x w x h	59 x 49 x 97 cm	84 x 55 x 97 cm
Cooking height	82 cm	83 cm
Cooking size	41 x 36 cm	41 x 36 cm
Material grill	cast aluminium	cast aluminium
Material lid	lacquered steel	lacquered steel
Material bowl	lacquered steel	lacquered steel
Material cart	lacquered steel	lacquered steel
Power	2 kW	2 kW
Storage space	✓	✓
Fat drainage	✓	✓
Fixed wheels		2
Cable length	180 cm	180 cm
Accessory hooks		✓
Quantity per pallet	14	14

Item ean



5 400269 210786



5 400269 210793

## MAKE YOUR ALEXIA COMPLETE WITH THESE ACCESSORIES



BC-ACC-7047  
Olivia nylon stainless steel gripper



BC-ACC-7036  
Olivia nylon spatula



BC-ACC-7012  
Nylon anti-scratch plancha spatula red



BC-ACC-7076  
Set of 100 bamboo skewers



BC-ACC-7099  
Pair of long cotton gloves black



BC-ACC-7058  
Cleaning brush





# SMOKERS

# Smoking?

Smoking food is hot & trendy! Smoking used to be an important method of preservation and the added flavour was only an after-thought. Today, it is the other way around; a smoker is primarily used to provide preparations with an extra delicious smokey flavour! Whether it is a piece of meat or fish, vegetables or fruit or even dairy products, anything is possible. All you need is the right smoking material and... a lot of time! After all, smoking can take several hours. Especially while cold smoking, you need some extra patience, but believe us, it is totally worth the wait. Expect unparalleled flavours from smoke-wood infused dishes!

In principle, you can prepare everything you put on the barbecue in the smoker/oven. Barbecue offers two different kinds of smokers, **the Oskar and the Otto**.

The flavour you add to dishes is determined by the kind of smoking wood you use. Barbecue offers a wide range of smoke chips, smoke chunks, smoke boards and smoke dust. Ready for your smoking adventure?

Convince your customers with our new smoking brochure full of tips & tricks and tasty recipes.



# Cold versus hot smoking

The big difference between hot and cold smoking is logically in the temperature.

For **cold smoking**, you put the spiral cold smoke generator of Barbecue in a Barbecue smoker or any barbecue with a lid. You fill the spiral with smoking dust that you let smoulder with a tea light. The smoking process takes four to ten hours. Please note: cold smoking only smokes your preparation, but does not cook it. **This takes place at a low temperature, between 20 and 25 °C.**

Important: are you planning to cold-smoke meat or fish? Then do not forget to brine them beforehand! This is crucial to avoid bacteria & moulds and to avoid food poisoning. You can brine your ingredients dry or wet.

If you have just a little less time or patience, then perhaps **warm smoking** is more for you. The higher temperature means a shorter smoking time and cooking time. With hot smoking, **it is important to maintain a constant temperature of 70°C.**

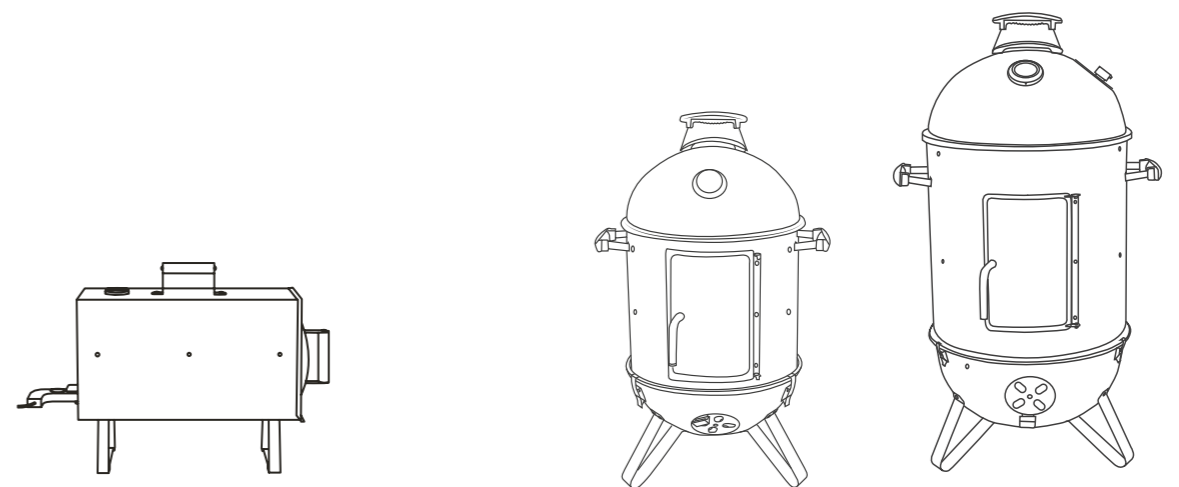

# OTTO 2.0

**NEW**



Never smoked before? Nothing is stopping you from trying it out. With the Otto electric smoker, you can do it from now on in 1, 2, 3. Place a handful of soaked smoking chips in the drawer, plug in the power cord and the fun can begin. Because of its simple use, you can easily prepare a salmon in less than 40 minutes. Soon you won't want anything else. Promise!

With our new Otto, you can smoke both cold and hot, and its compact size and handle make it easy to take with you wherever you go. So you have an electric oven at hand everywhere.

ROKEN

Thermometer for perfect control.

Thermostat with range from 100°C to 250°C.

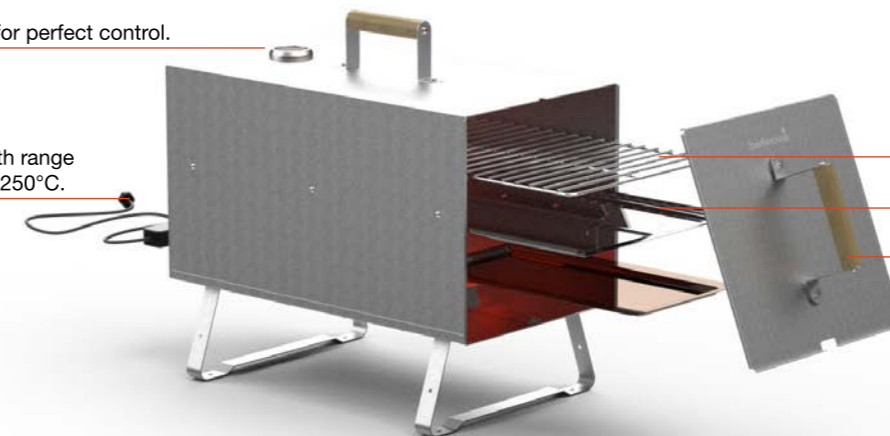

Includes food grid, drip tray and smoking chips tray.

2 different grid heights.

Wooden handles for cold grip.



## OTTO 2.0

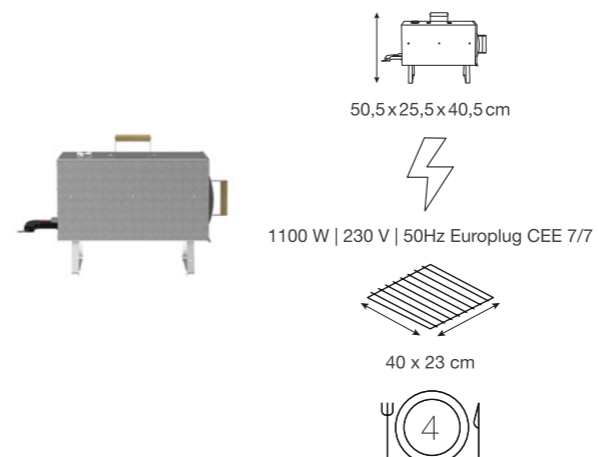

# OTTO

**OTTO 2.0**  
BC-SMO-5022

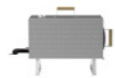

Number of persons	4
Dimensions l x w x h	50,5x25,5x40,5cm
Adjustable grids	2 positions ✓
Cooking size	40 x 23 cm
Material grill	stainless steel
Material feet	stainless steel
Material tray	stainless steel
Power	1.1 kW
Fat drainage	✓
Cable length	150 cm
Quantity per pallet	48

Item ean



## MAKE YOUR OTTO COMPLETE WITH THESE ACCESSORIES



BC-SMO-5031  
Smoking chips oak  
whiskey



BC-SMO-5000  
Smoking chips apple



BC-SMO-5021  
Cold smoke  
generator



BC-SMO-5042  
Smoking dust oak  
red wine



BC-ACC-7096  
Cotton glove red



BC-ACC-7125  
Fish turner FSC®



# OSKAR



Immerse yourself in the aromatic world of smoking and surprise friends (and foes) with your grilling skills. The Barbecue Smokers give your food an authentic taste, brimming with character. You can use them for hot or cold smoking. Whether you're smoking salmon, trout, or a piece of game, the sturdy grills and suspension hooks help you achieve the desired result. Enjoy their ease of use and experiment with various types of Barbecue smoking chips, dust or chunks.

Enamelled finish for simple maintenance.

Integrated thermometer.

Solid grills and sturdy hooks for various preparations.

Maintain perfect control thanks to the adjustable air supply.



OSKAR S



86 cm



Ø 40 cm

OSKAR M



112 cm



Ø 42 cm

# OSKAR

**OSKAR S**  
BC-SMO-5017



**OSKAR M**  
BC-SMO-5014



Dimensions l x w x h	58x50x86cm	61x54x112cm
Cooking size	Ø 40cm	Ø 42cm
Material grill	chrome-plated steel	chrome-plated steel
Material lid	enamelled steel	enamelled steel
Material bowl	enamelled steel	enamelled steel
Material feet	stainless steel	stainless steel
Adjustable airsupply	✓	✓
Ash container	✓	✓
Lid with thermometer	✓	✓
Quantity per pallet	8	6

Item ean



5 400269 206956



5 400269 205171



## SUITABLE COVER



BC-ACC-7170  
Premium barbecue  
cover

## MAKE YOUR OSKAR COMPLETE WITH THESE ACCESSORIES



BC-SMO-5021  
Cold smoke gen-  
erator



BC-SMO-5040  
Smoking dust oak



BC-SMO-5005  
Smoking chips lemon



BC-SMO-5060  
3 kinds of smoking  
chips oak, whiskey  
and red wine



BC-SMO-7437  
Bucket with smoking  
chips oak whiskey



BC-ACC-7040  
Olivia stainless steel  
spiral brush



BC-ACC-7052  
Premium pair of  
gloves black



BC-ACC-7015  
Meat and rib rack



BC-SMO-5011  
Set of 2 smoking  
planks cedar wood



BC-ACC-7211  
Stainless steel  
saucepot with brush  
23x7.5x10.5cm



BC-SMO-5053  
Wood chunks oak



BC-ACC-7448  
Lighter

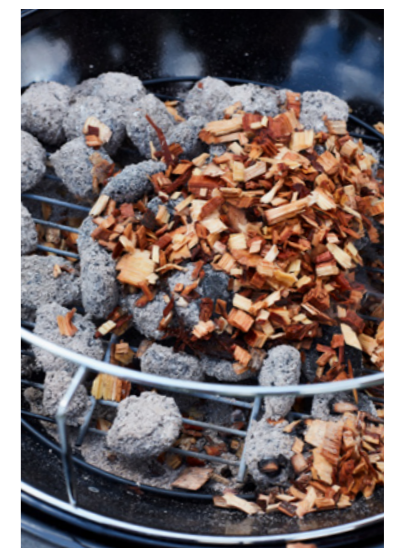





# NESTOR



Gather around the fire and enjoy the ultimate outdoor cooking experience with friends and family. With Nestor, you can barbecue all year round. This barbecue is a real eye-catcher in your garden and is guaranteed to provide many cosy evenings.

WOOD

Easy to expand with the Dynamic Centre accessories.

Sizzle zone to create the perfect grillmarks.

Thanks to the raised rim, there are no grease drops on the terrace and ingredients cannot fall off the cooking plate.

2 removable cooking plates made of 6 mm carbon steel.

Handles for easy assembly and transportation.

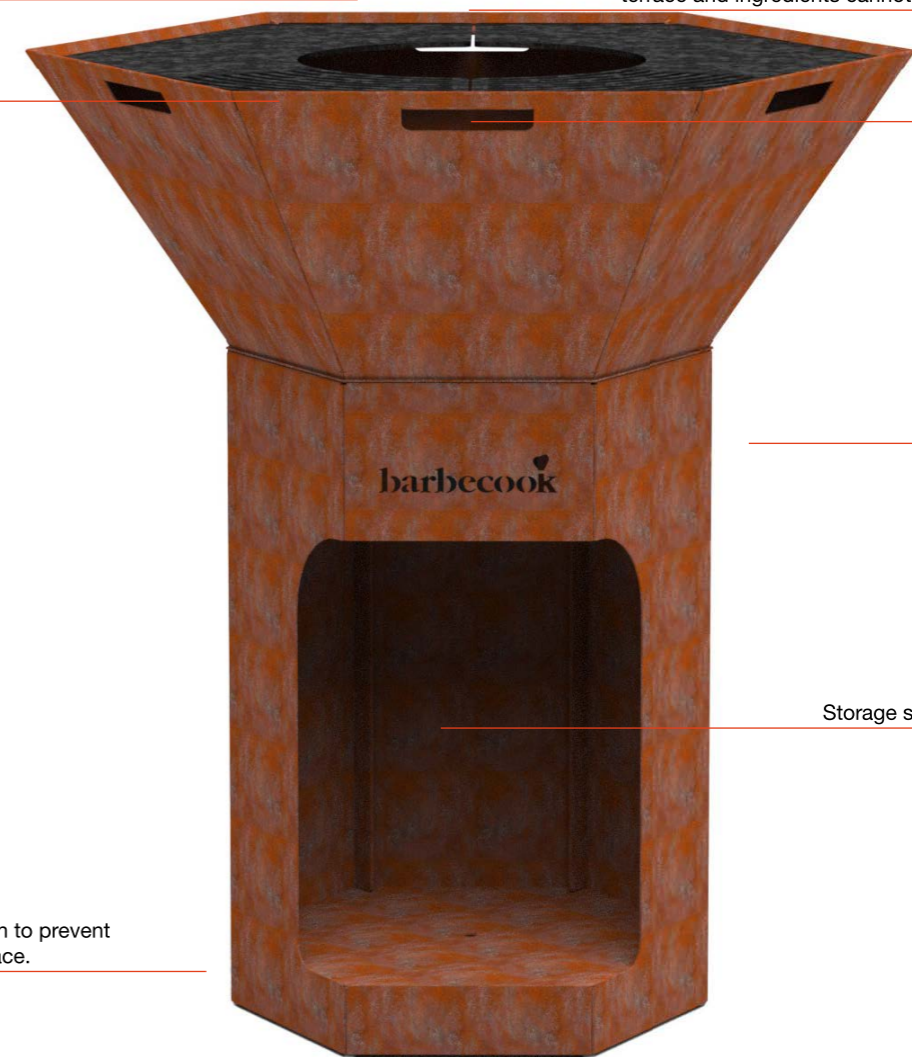

Integrated ash container.

Storage space for wood and tools.

Plastic feet underneath to prevent rust stains on the terrace.

NESTOR ORIGINAL BLACK



NESTOR ORIGINAL CORTEN STEEL



# NESTOR

**NESTOR ORIGINAL BLACK**  
BC-WOO-6022

**NESTOR ORIGINAL  
CORTEN STEEL**  
BC-WOO-6023



Number of persons	14	14
Dimensions l x w x h	92x92x101 cm	92x92x101 cm
Cooking height	100cm	100cm
Cooking size	91 x 91 cm	91 x 91 cm
Material grill	carbon steel	carbon steel
Material bowl	galvanised steel	corten steel
Ash container	✓	✓
Storage space	✓	✓

Item ean



5 404035 700785



5 404035 700792

## MAKE YOUR NESTOR COMPLETE WITH THESE ACCESSORIES



BC-ACC-7453  
Dynamic Centre  
stand and elevated  
grill for Nestor

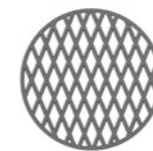

BC-ACC-7454  
Dynamic Centre  
sear grate ø36cm for  
Nestor



BC-ACC-7455  
Dynamic Centre  
skewer holder for  
Nestor



BC-ACC-7456  
Dynamic Centre wok  
& Dutch oven holder  
for Nestor

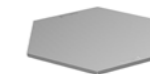

BC-ACC-7457  
Tabletop cover for  
Nestor



BC-ACC-7052  
Premium pair of  
gloves black



BC-ACC-7426  
Wood wool firelighters  
32 pieces FSC®



BC-ACC-7222  
Set of 40 long  
matches



BC-ACC-7154  
Cutting table made of  
bamboo



BC-ACC-7219  
Hamburger press



BC-ACC-7123  
Set of 2 plancha  
turners FSC®



# JUNKO



barbecue

With its original and surprising design, Junko appeals to real daredevils. Are you going wild over this appliance and can't wait to try it out? No problem! Thanks to the ready-to-start package (tripod, grill and fire basket) you will be able to put your grilling instinct to the test straight away.

WOOD

Convenient pulley to adjust cooking height.

Carrying bag included.

Grill can be taken out for accessories.

Sturdy chain.

JUNKO



60 x 60 x 166 cm

60 cm

14

# JUNKO

**JUNKO**  
BC-WOO-6000



Dimensions l x w x h	60x60x166 cm
Cooking size	60 cm
Material grill	chrome-plated steel
Material bowl	lacquered steel
Material feet	powder coated steel
Quantity per pallet	18

Item ean



5 400269 202156



SUITABLE COVER INCLUDED



MAKE YOUR JUNKO COMPLETE WITH THESE ACCESSORIES



BC-WOO-6006  
Junko cast iron wok



BC-WOO-6002  
Junko barbecue pan



BC-WOO-6017  
Junko grill chrome



BC-WOO-6009  
Junko cast iron Dutch  
Oven 0.7L



BC-WOO-6008  
Junko cast iron Dutch  
Oven 3L



BC-WOO-6007  
Junko cast iron Dutch  
Oven 9L



BC-ACC-7426  
Wood wool firelighters  
32 pieces FSC®



BC-ACC-7052  
Premium pair of  
gloves black

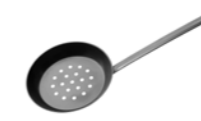

BC-ACC-7107  
Chestnut pan made  
of lacquered steel  
black



BC-ACC-7093  
Set of 4 skewers  
FSC®



BC-ACC-7091  
Sausage tongs



BC-ACC-7071  
Turner FSC®

# RILA



Cooking together around the fire. With Rila, you have a barbecue and fire basket in one! Multi-functionality is not the only advantage to Rila. Its wide legs keep it stable while you grill and the surface heats up quickly, so you can start cooking immediately after lighting the fire. This trendy geometric fire basket will be the new eye-catcher in your home.

WOOD

The carbon steel griddle is perfect for cooking all sorts of food.

The painted sheet steel is heat-resistant up to 600°C.



The wide base ensures optimal stability.

The wire mesh pedestal can be easily assembled and dismantled.

RILA  
BC-WOO-6016



Dimensions l x w x h	80 x 75 x 71 cm
Cooking height	71 cm
Material grill	carbon steel
Material bowl	lacquered steel
Accessory hooks	✓
Quantity per pallet	10

Item ean



## MAKE YOUR RILA COMPLETE WITH THESE ACCESSORIES



BC-ACC-7057  
Wooden brush FSC®



BC-ACC-7123  
Set of 2 plancha turners FSC®



BC-ACC-7125  
Fish turner FSC®



BC-ACC-7072  
Fork FSC®



BC-ACC-7222  
Set of 40 long matches



BC-ACC-7070  
Luxury tongs FSC®

# JACK



barbecook

# JILL



Create a cosy atmosphere with the Barbecook fire baskets and fire bowls. These trendy shaped eye-catchers create a crackling play of flames on your patio. After all, what is better than having some great conversations around the fire after enjoying a delicious barbecue?

WOOD

	<b>JACK 60</b> BC-WOO-6018	<b>JACK 75</b> BC-WOO-6019	<b>JILL</b> BC-WOO-6020
			
Dimensions l x w x h	60x60x25 cm	75x75x30 cm	38x38x55 cm
Material bowl	corten steel	corten steel	corten steel
Quantity per pallet	20	17	36
Item ean	 5 420059 856178	 5 420059 856185	 5 420059 859629



After the first use, your fire bowl will gradually get a nice rusty colour. This process can take up to a few months.

### MAKE YOUR JACK COMPLETE WITH THESE ACCESSORIES



BC-PLA-3011  
Carbon steel plancha  
75cm



BC-PLA-3010  
Carbon steel plancha  
62cm



BC-ACC-7447  
Steel spark screen  
black 75cm



BC-ACC-7446  
Steel spark screen  
black 62cm



BC-ACC-7223  
Cooking grill for fire pit  
62cm



BC-ACC-7224  
Cooking grill for fire pit  
75cm

# FIREPITS



barbecue

**CLASSIC SQUADRA**  
BC-WOO-6012



**JURA**  
BC-WOO-6013



**MODERN RONDA**  
BC-WOO-6010



Dimensions l x w x h	62 x 62 x 49 cm	42,5 x 42,5 x 70 cm	42,5 x 42,5 x 63 cm
Material bowl	lacquered steel	lacquered steel	lacquered steel
Quantity per pallet	25	30	60

Item ean



5 400269 227296



5 400269 207533



5 400269 223151

**MODERN 60**  
BC-WOO-6005



**MODERN 75**  
BC-WOO-6003



**SIERRA**  
BC-WOO-6015



Dimensions l x w x h	60 x 60 x 33 cm	75 x 75 x 32 cm	45 x 45 x 71 cm
Material bowl	cast iron	cast iron	lacquered steel
Quantity per pallet	15	11	28

Item ean



5 400269 221942



5 400269 227357



5 400269 209513

## MAKE YOUR FIREPIT COMPLETE WITH THESE ACCESSORIES



BC-PLA-3011  
Carbon steel plancha  
75cm



BC-PLA-3010  
Carbon steel plancha  
62cm



BC-ACC-7447  
Steel spark screen  
black 75cm



BC-ACC-7446  
Steel spark screen  
black 62cm



BC-ACC-7223  
Cooking grill for fire pit  
62cm



BC-ACC-7224  
Cooking grill for fire pit  
75cm



barbecook

# ACCESSORIES







**BC-ACC-7413**

16,5x16,5x27,5cm  
24 8 stainless steel

**Charcoal starter with safe drop stainless steel**  
 · Tool for easy and quick lighting of charcoal barbecues, smoker and fire pits.  
 · With safe-drop system.  
 · Handle with a heat resistant deflector plate.



**BC-ACC-7449**

**NEW**

30x21x28cm 6,25L  
0 1 enamelled steel

**Charcoal starter for Magnus**  
 · Tool for easy and quick lighting of the charcoal barbecue Magnus.  
 · Soft and cold grip.  
 · Heat resistant deflector plate.



**BC-ACC-7117**

3x3x25cm 1L  
12 1

**Lighting gel 1L**  
 · Environmentally friendly and powerful gel.  
 · Suitable for starting your barbecue.  
 · Also usable in fireplace.  
 · Doesn't leave behind any harmful substances.



**BC-ACC-7222**

0,3x0,3x19,5cm  
20 20 wood

**Set of 40 long matches**  
 · Suitable for lighting your charcoal barbecue, smoker or fire basket.  
 · Set of 40 matches.



**BC-ACC-7448**

**NEW**

0 1

**Lighter**  
 · Suitable for lighting your charcoal barbecue, smoker or fire basket.  
 · Flexible head.  
 · Refillable.  
 · Adjustable flame size.



**BC-ACC-7184**

63x4,4x119cm  
12 1

**Gas regulator The Netherlands with hose 30mbar**  
 · Suitable for connecting the gas to the gas barbecue.  
 · G5 connection.  
 · The tube has a length of 75cm.  
 · Exclusively for the Dutch market.



**BC-ACC-7113**

14x9x29,5cm  
12 1 wood

**Bag of 72 lighter cubes FSC®**  
 · Schnelles Anzünden von Holzkohlegrill oder Smoker.  
 · DIN-certified.



**BC-ACC-7426**

12x12x19,2cm  
12 12 wood

**Wood wool firelighters 32 pieces FSC®**  
 · Fast lighting of a charcoal barbecue, smoker or fire basket.  
 · FSC®-labeled.  
 · Between 8 & 10 minutes burning time.  
 · 100% natural.



**BC-ACC-7186**

63x4,4x119cm  
12 1

**Gas regulator Belgium and Luxembourg with hose 37mbar**  
 · Suitable for connecting the gas to the gas barbecue.  
 · G5 connection.  
 · The tube has a length of 75cm.  
 · Exclusively for the Belgian & Luxembourg market.



**BC-ACC-7188**

21x5x27cm  
12 1

**Gas regulator France with hose 37mbar**  
 · Suitable for connecting all Barbecue gas barbecues to the gas bottle.  
 · G2 connection.  
 · Operating pressure: 37mbar (propane).  
 · Connection G20/150 for gas hose.  
 · Exclusively for the French market (NF).



**BC-ACC-7425**

24x11x52cm 5kg  
60 60 candlenut shells, coconut shells, topioca starch

**Premium coconut briquettes 5kg**  
 · 240 minutes burning time.  
 · 100% natural.



**BC-ACC-7421**

55x18,5x105cm 6kg  
1 42 alder

**Premium charcoal FSC® 6kg**  
 · Fast lighting of a charcoal barbecue or smoker, ready to grill in 12-15 minutes.  
 · Restaurant quality charcoal made only from naturally dried lump wood alder. Has a pleasant natural flavour with great tasting.  
 · High rate of fixed carbon secures longer burning time.  
 · Large pieces  
 · 100% natural.  
 · Made in EU



**BC-ACC-7190**

21x5x27cm  
12 1

**Gas regulator Italy and Greece with hose 30mbar**  
 · Suitable for connecting all Barbecue gas barbecues to the gas bottle.  
 · G1 connection.  
 · Operating pressure: 29mbar (lpq).  
 · Pigtail connection for gas hose.  
 · Exclusively for the Italian/Greek market.





# COOKING

barbecue

## BC-ACC-7069

6x4,5x40 cm  
12 1 rubber wood, stainless steel

**Tongs FSC®**  
· Suitable for turning your preparations.  
· FSC®-labeled.



## BC-ACC-7070

5x3x40 cm  
12 1 rubber wood, stainless steel

**Luxury tongs FSC®**  
· Suitable for turning your preparations.  
· FSC®-labeled.



## BC-ACC-7071

7x2x46 cm  
12 1 rubber wood, stainless steel

**Turner FSC®**  
· Suitable for turning your preparations.  
· FSC®-labeled.  
· Convenient storage with hanging loop.



## BC-ACC-7072

3x2x46 cm  
12 1 rubber wood, stainless steel

**Fork FSC®**  
· Suitable for turning your preparations.  
· FSC®-labeled.  
· Convenient storage with hanging loop.



## BC-ACC-7057

3x2x47 cm  
12 1 rubber wood

**Wooden brush FSC®**  
· Suitable for marinating your preparations.  
· FSC®-labeled.



## BC-ACC-7062

12x1,5x30 cm  
12 1 rubber wood, stainless steel

**Hamburger turner FSC®**  
· Suitable for flipping burgers.  
· Made of stainless steel.  
· FSC®-labeled.



## BC-ACC-7123

12x31x1,5 cm  
6 1 rubber wood, stainless steel

**Set of 2 plancha turners FSC®**  
· Suitable for turning your preparations.  
· FSC®-labeled.  
· Convenient storage with hanging loop.  
· Set of 2 spatulas.



## BC-ACC-7125

7,5x37x1,5 cm  
6 1 rubber wood, stainless steel

**Fish turner FSC®**  
· Suitable for turning a delicate piece of fish.  
· FSC®-labeled.  
· Convenient storage with hanging loop.



## BC-ACC-7225

63x32x7 cm  
4 1 stainless steel, wood

**Pizza spatula FSC®**  
· Suitable for putting a pizza on your barbecue and taking it off.  
· Extra large blade.  
· FSC®-labeled.



## BC-ACC-7094

8x5,5x47 cm  
6 1 rubber wood, stainless steel

**3-Piece standard set FSC®**  
· Includes a spatula, fork and tong.  
· FSC®-labeled.  
· Convenient storage with hanging loop.



## BC-ACC-7025

3,5x1,5x38 cm  
6 1 ABS, stainless steel, TPR

**Army Style fork**  
· Khaki green handle.  
· Suitable for turning meat, fish and vegetables.  
· Easy to clean.



## BC-ACC-7026

8,5x1,5x38 cm  
6 1 ABS, stainless steel, TPR

**Army Style turner**  
· Khaki green handle.  
· Suitable for turning meat, fish and vegetables.  
· Easy to clean.



## BC-ACC-7028

5x4x38 cm  
6 1 ABS, stainless steel, TPR

**Army Style tongs**  
· Khaki green handle.  
· Suitable for turning meat, fish and vegetables.  
· Easy to clean.



## BC-ACC-7045

4x3x42 cm  
8 1 glass fiber, nylon, stainless steel

**Olivia stainless steel universal gripper**  
· Suitable for turning your preparations.  
· Convenient storage with hanging loop.



**BC-ACC-7046**

4x3x42 cm  
 8 1 glass fiber,nylon,stainless steel

- Olivia stainless steel salad gripper**
- Suitable for serving salades.
  - Convenient storage with hanging loop.

**BC-ACC-7047**

4x3x42 cm  
 8 1 glass fiber,nylon,stainless steel

- Olivia nylon stainless steel gripper**
- Suitable for turning your preparations.
  - Convenient storage with hanging loop.

**BC-ACC-7041**

5,5x2x35,5 cm  
 8 1 glass fiber,nylon,stainless steel

- Olivia stainless steel big chef's knife**
- Suitable for cutting, chopping or mincing your preparations.
  - Ergonomic handle.

**BC-ACC-7042**

4x2x33 cm  
 8 1 glass fiber,nylon,stainless steel

- Olivia stainless steel boning knife**
- Suitable for cutting around a bone very precisely to loosen as much meat as possible.
  - Ergonomic handle.

**BC-ACC-7037**

4,5x2,5x43 cm  
 8 1 glass fiber,nylon,stainless steel

- Olivia stainless steel fork**
- Suitable for turning your preparations.
  - Convenient storage with hanging loop.

**BC-ACC-7033**

11,8x2,5x42 cm  
 8 1 glass fiber,nylon,stainless steel

- Olivia stainless steel spatula**
- Suitable for turning your dishes.
  - Convenient storage with hanging loop.

**BC-ACC-7043**

4x2x39,5 cm  
 8 1 glass fiber,nylon,stainless steel

- Olivia stainless steel bread knife**
- Suitable for cutting bread and cake.
  - Ergonomic handle.

**BC-ACC-7044**

10x2x22,5 cm  
 8 1 glass fiber,nylon,stainless steel

- Olivia stainless steel pizza cutter**
- Suitable for cutting pizza.
  - Ergonomic handle.

**BC-ACC-7034**

19x46x43 cm  
 8 1 glass fiber,nylon,stainless steel

- Olivia stainless steel pizza spatula**
- Suitable for putting a pizza on your barbecue and taking it off.
  - Convenient storage with hanging loop.

**BC-ACC-7035**

13,5x2,5x42 cm  
 8 1 glass fiber,nylon,stainless steel

- Olivia stainless steel fish spatula**
- Suitable for turning a delicate piece of fish.
  - Convenient storage with hanging loop.

**BC-ACC-7048**

3,5x20x22 cm  
 8 1 glass fiber,nylon,stainless steel

- Olivia stainless steel cutting knife**
- Suitable for cutting and peeling vegetables and fruit.
  - Ergonomic handle.

**BC-ACC-7049**

3,5x2x25 cm  
 8 1 glass fiber,nylon,stainless steel

- Olivia set of 4 stainless steel steak knives**
- Suitable for cutting meat.
  - Ergonomic handle.
  - Set of 4 steak knives.

**BC-ACC-7036**

11,8x2,5x43 cm  
 8 1 glass fiber,nylon,stainless steel

- Olivia nylon spatula**
- Suitable for turning your preparations.
  - Convenient storage with hanging loop.

**BC-ACC-7038**

4,5x2,5x26,5 cm  
 8 1 glass fiber,nylon,stainless steel

- Olivia stainless steel marinade brush**
- Suitable for marinating your preparations.
  - Convenient storage with hanging loop.

**BC-ACC-7012**

11x2x37,5 cm  
 8 1 nylon

- Nylon anti-scratch plancha spatula red**
- Suitable for turning your preparations.
  - Does not scratch.
  - For safe use with the Plancha Thermicore and Victor.

**BC-ACC-7024**

11x4,5x46 cm  
 6 1 stainless steel

- Black Pepper BBQ set with fork, tongs and turner**
- Includes a spatula, fork and tong.
  - Dishwasher safe.
  - Quality tools with a beautiful design.



**BC-ACC-7091**

9x3,5x40 cm  
 12 1 chrome,PVC

**Sausage tongs**

- Suitable for turning sausages or other preparations.
- Heat resistant PVC handle.
- Made of chrome.

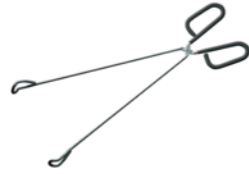
**BC-ACC-7419**

2,6x2,1 x39,8 cm  
 24 1 stainless steel

**Stainless steel sausage tongs**

- Easy turning of sausages on the barbecue.
- Wheels ensure that no holes are punctured in the sausages.

**BC-ACC-7059**

41 x2x62 cm  
 6 6 chrome,rubber wood

**Elastic grill FSC®**

- Suitable for easily turning your preparations.
- FSC®-labeled.
- Easy to clean.

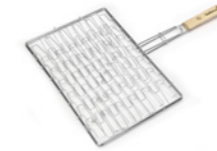
**BC-ACC-7061**

31,5x5x64 cm  
 6 6 chrome,rubber wood

**Double grill basket FSC®**

- Suitable for easily turning your preparations.
- Convenient raised edges.
- FSC®-labeled.
- Easy to clean.

**BC-ACC-7092**

4,5x1,3x23 cm  
 12 1 silicone,stainless steel

**Silicone brush**

- Suitable for marinating your preparations.
- Heat resistant to 250°C.

**BC-ACC-7093**

4,2x4,2x46 cm  
 12 1 rubber wood,stainless steel

**Set of 4 skewers FSC®**

- Reusable skewers.
- With shear ring.
- FSC®-labeled.

**BC-ACC-7104**

35x3x52,5 cm  
 6 6 chrome,rubber wood

**Hamburger grill FSC®**

- Suitable for evenly roasting hamburgers.
- Perfect for preparing 6 hamburgers.
- FSC®-labeled.

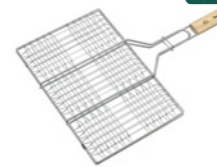
**BC-ACC-7105**

14,5x2x66 cm  
 6 6 chrome,rubber wood

**Fish grill FSC®**

- Suitable for grilling one fish.
- Prevents fish from sticking to the grill.
- FSC®-labeled.

**BC-ACC-7068**

1,5x1,5x43 cm  
 12 1 chrome,rubber wood

**Set of 4 skewers FSC®**

- Reusable skewers.
- FSC®-labeled.
- Easy to clean.

**BC-ACC-7073**

2,5x0,5x33 cm  
 12 1 stainless steel

**Set of 10 stainless steel skewers**

- Reusable skewers.
- A rounded end so ingredients don't slide off the skewer.

**BC-ACC-7106**

2x59x28 cm  
 6 6 chrome,rubber wood

**Fish grill for 3 fish FSC®**

- Suitable for grilling 3 fishes.
- Prevents fish from sticking to the grill.
- FSC®-labeled.

**BC-ACC-7095**

36x2x72,5 cm  
 6 6 chrome,rubber wood

**Double broiler FSC®**

- Suitable for easily turning your preparations.
- Chromed grid.
- FSC®-labeled.

**BC-ACC-7076**

0,3x0,3x30 cm  
 20 1 bamboo

**Set of 100 bamboo skewers**

- Set of 100 skewers.
- Made of bamboo.

**BC-ACC-7090**

8x2,5x51 cm  
 12 1 chrome,rubber wood

**Sausage grill FSC®**

- Suitable for grilling 4 sausages.
- Easy to lock grid.
- FSC®-labeled.
- Also suitable for grilling vegetables.

**BC-ACC-7075**

35x6,5x31 cm  
 24 1 stainless steel

**Stainless steel grill topper**

- Prevents preparations from falling between the grid.
- Easy to grill appetizers.
- Dishwasher safe.
- 2 large handles to move the grid easily.

**BC-ACC-7082**

34x23x2,5 cm  
 24 1 aluminum

**Set of 5 square aluminium barbecue plates**

- Keeps the grill clean.
- Set of 5 disposable trays.



**BC-ACC-7079**

24x34,5x3cm  
 12 1 stainless steel

**Reusable stainless steel grill pan**

- Can be used on both a charcoal and gas barbecue.
- Dishwasher safe.
- Keeps the grill clean.
- Made of stainless steel.

**BC-ACC-7080**

24x34,5x3cm  
 12 1 enamel

**Reusable enamel grill pan**

- Can be used on both a charcoal and gas barbecue.
- Dishwasher safe.
- Keeps the grill clean.
- Made of enamel.

**BC-ACC-7086**

22x4,8x12cm  
 6 1 plastic, stainless steel

**Digital thermometer with app**

- Measurement range from -45°C to 200°C.
- Available for Android and iOS.
- Includes two 1,5V batteries.
- Made of stainless steel and easy to maintain.

**BC-ACC-7087**

43,3x35,9x2cm  
 4 1 enamelled cast iron

**Cooking griddle for charcoal barbecue**

- Contact plate for all Barbecue charcoal barbecues.
- Ensures even distribution of heat.
- Easy to clean.
- Double-sided: one flat and one ribbed side.

**BC-ACC-7420**

27x23x3,5cm  
 2 1 bamboo, cast iron

**Cast iron grill pan with bamboo trivet**

- Easy baking of small ingredients on a barbecue.
- Made of cast-iron, therefore extremely qualitative.
- With detachable handle.
- Including bamboo base to serve preparations.

**BC-ACC-7083**

36x42x0,1cm  
 6 6 glass fiber

**Grill mesh**

- Prevents preparations from sticking to the grill.
- Icfion® coating.
- Non-stick coating.
- Suitable for small preparations.

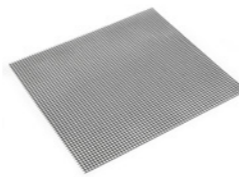
**BC-ACC-7088**

42x24x1,5cm  
 4 1 enamelled cast iron

**Cooking griddle Brahma**

- Contact plate for the Barbecue Brahma charcoal barbecue.
- Ensures even distribution of heat.
- Easy to clean.
- Double-sided: one flat and one ribbed side.

**BC-ACC-7126**

43x35x2cm  
 4 1 enamelled cast iron

**Universal cooking griddle of enamelled cast iron**

- Universal contact plate.
- Suitable for use on all Barbecue Siesta and Stella gas barbecues.
- Easy to clean.
- Double-sided: one flat and one ribbed side.

**BC-ACC-7411**

40x40x0,1cm  
 12 1 glass fiber

**Set of 2 grill mats black Ø 40cm**

- Prevents food from sticking to and slipping through the grid.
- Keeps the grid clean.
- Thickness of 0,1 mm.

**BC-ACC-7438**

32x32x0,22cm  
 6 1 glass fiber, PTFE

**Set of 2 Premium grill mat black Ø 32cm**

- Prevents food from sticking to and slipping through the grid.
- Keeps the grid clean.
- Thickness of 0,22 mm.

**BC-SPA-8662**

45x23x1,5cm  
 5 1 enamelled cast iron

**Cast iron griddle**

- Suitable for the Barbecue Spring, Kaduva and Impuls gas barbecue.
- Easy to clean.
- Double-sided: one flat and one ribbed side.

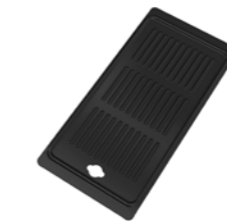
**BC-ACC-7013**

36x36x4cm  
 6 1 clay

**Universal pizza stone made of refractory clay**

- Made of refractory clay.
- Can be used on both a charcoal and gas barbecue.
- After cooling, easy to clean by hand.

**BC-ACC-7439**

40x33x0,22cm  
 6 1 glass fiber, PTFE

**Set of 2 Premium grill mat black 40x33cm**

- Prevents food from sticking to and slipping through the grid.
- Keeps the grid clean.
- Thickness of 022 mm.

**BC-ACC-7078**

2,6x1,8x13,8cm  
 6 1 plastic, stainless steel

**Digital pocket thermometer**

- Measurement range from -30°C to 260°C.
- Folds perfectly into your pocket.

**BC-ACC-7127**

43x35x1,2cm  
 4 1 clay

**Universal pizza stone made of refractory clay**

- Made of refractory clay.
- Can be used on both a charcoal and gas barbecue.
- After cooling, easy to clean by hand.

**BC-ACC-7015**

34,5x15x20cm  
 6 1 stainless steel

**Meat and rib rack**

- Perfect for cooking large cuts of meat or ribs.
- Practical handles.
- Suitable for 6 spareribs.
- When you flip it over, it can be used as a tub for larger pieces of meat.
- Dishwasher safe.



**BC-ACC-7017**

26,5x4,5x35,5 cm

6 1 stainless steel

**Brochette holder**

- Suitable for preparing 5 brochettes.
- Can be used on both a charcoal and gas barbecue.



5 400269 238728

**BC-ACC-7167**

18,5x18,5x27,5 cm

6 1 stainless steel

**Poultry roaster**

- Allows you to add additional flavors such as wine, beer, broth.
- Easy to use.
- Includes grease tray.
- Dishwasher safe.
- Can also be used in the oven.



5 400269 238810

**BC-ACC-7165**

8,7 cm

10 1 chrome-plated steel

**Set for gas barbecue with 2 spit forks**

- Rotisserie set for a gas barbecue.
- Suitable for the Barbecue Brahma, Quisson and Stella gas barbecue.
- Features two spit forks and two loops.
- Batteries (2 x D LR20) are not included.



5 400269 224325

**BC-ACC-7166**

8,7 cm

10 1 chrome-plated steel

**Set for gas barbecue with 2 spit forks**

- Rotisserie set for a gas barbecue.
- Suitable for the Barbecue Kaduva, Manua 2, Vanilla, Impuls 40, Spring and Sumo gas barbecue.
- Features two spit forks and two loops.
- Batteries (2 x D LR20) are not included.



5 400269 233174

**BC-ACC-7168**

37,5x2x15,5 cm

6 1 stainless steel

**Drumsticks rack**

- Suitable for preparing 12 drumsticks.
- Includes tray to catch dripping grease.
- Easy to clean.



5 400269 240516

**BC-ACC-7129**

30x30x17 cm

4 1 stainless steel

**Olivia stainless steel plancha dome Ø 30cm**

- Suitable for evenly roasting, cooking and gratinating your dishes.
- Easy to use in combination with a plancha griddle.
- Easy to clean.



5 400269 235062

**BC-ACC-7211**

10,5x7,5x23 cm

8 1 silicone, stainless steel

**Stainless steel saucepot with brush 23x7.5x10.5cm**

- Perfect to prepare marinades.
- Silicone marinade brush included.
- Easy to maintain.



5 420059 844786

**BC-ACC-7213**

24x0,3x35 cm

12 1 aluminum, polyester

**Set of 10 oven and barbecue bags**

- Suitable for barbecue and oven.
- Keeps your barbecue grid clean.
- Withstands maximum temperature of 200°C.
- Set of 10 bags.



5 420059 844809

**BC-ACC-7030**

43x43x15 cm

40 1 stainless steel

**Charcoal barbecue dome Loewy 45**

- Suitable for charcoal barbecue Optima and Loewy 45.
- Suitable for evenly roasting, cooking and gratinating your dishes.
- Easy to clean.



5 400269 239879

**BC-ACC-7032**

50x50x20 cm

28 1 stainless steel

**Charcoal barbecue dome Loewy 50**

- Suitable for charcoal barbecue Major, Loewy 50 en Adam 50.
- Suitable for evenly roasting, cooking and gratinating your dishes.
- Easy to clean.



5 400269 239862

**BC-ACC-7215**

7x3,5x14,5 cm

6 1 ABS, plastic, stainless steel

**Marinade injector**

- Ideal for marinating preparations.
- Marinade penetrates the food.



5 420059 844823

**BC-ACC-7219**

11,5x11,5x8 cm

6 1 aluminum

**Hamburger press**

- Easy tool to prepare homemade burgers.
- Easy to use.
- Easy to clean.



5 420059 844861

**BC-ACC-7163**

13x9x68 cm

4 1 chrome-plated steel

**Siesta universal spit black with 2 forks**

- Universal spit with motor.
- Suitable for the Barbecue Siesta gas barbecues.
- Features two spit forks.
- Batteries (2 x D LR20) are not included.



5 400269 204068

**BC-ACC-7164**

6x6x85 cm

6 1 chrome-plated steel

**Spit with 2 forks with motor for charcoal barbecue**

- Universal spit with motor.
- Suitable for the Barbecue Loewy.
- Features two spit forks.
- Batteries (1 x D LR20) are not included.



5 400269 216443

**BC-ACC-7220**

24,5x7x8,5 cm

4 1 aluminum

**Mini hamburger press for 3 burgers**

- Easy tool to prepare homemade mini burgers.
- Easy to use.
- Large handle allowing you to press the burgers simultaneously.
- Easy to clean.



5 420059 844878

**BC-ACC-7221**

13,6x9,4x10,5 cm

6 1 chrome, rubber wood

**Hasselback potato prep set**

- Recessed board so you don't cut the potato completely.
- Ensures parallel indentations in the potato.
- Also suitable for vegetables and mozzarella.
- The metal part is dishwasher safe.



5 420059 844885

**BC-ACC-7300**

30x20x1,5cm  
 6 1 bamboo

**Bamboo cutting board FSC® 30x20x1.5cm**

- Easy cutting & processing of ingredients.
- FSC®-labeled.
- Doesn't dull knives.
- Absorbs hardly any moisture, so doesn't deform.
- Extremely hygienic.

**BC-ACC-7301**

40x30x1,5cm  
 6 1 bamboo

**Bamboo cutting board FSC® 40x30x1.5cm**

- Easy cutting & processing of ingredients.
- FSC®-labeled.
- Doesn't dull knives.
- Absorbs hardly any moisture, so doesn't deform.
- Extremely hygienic.

**BC-ACC-7308**

43x28x2cm  
 6 1 bamboo

**Bamboo cutting board with groove FSC® 43x28x2cm**

- Easy cutting & processing of ingredients.
- FSC®-labeled.
- With juice channel.
- 4 black feet.
- Doesn't dull knives.

**BC-ACC-7154**

70x43x81cm  
 30 1 bamboo

**Cutting table made of bamboo**

- Handy folding table.
- Side table for when grilling.
- Easy to store.
- Easy to clean.

**BC-ACC-7302**

20x15x2cm  
 6 1 bamboo

**Bamboo cutting board FSC® 20x15x2cm**

- Easy cutting & processing of ingredients.
- FSC®-labeled.
- Doesn't dull knives.
- Absorbs hardly any moisture, so doesn't deform.
- Extremely hygienic.

**BC-ACC-7303**

33x16x2cm  
 6 1 bamboo

**Bamboo cutting board FSC® 33x16x2cm**

- Easy cutting & processing of ingredients.
- FSC®-labeled.
- Doesn't dull knives.
- Absorbs hardly any moisture, so doesn't deform.
- Extremely hygienic.

**BC-ACC-7350**

46x25x9,4cm  
 2 1 bamboo

**Bamboo box for barbecue tools FSC®**

- Storage box & cutting board in one.
- FSC®-labeled.
- Doesn't dull knives.
- Absorbs hardly any moisture, so doesn't deform.
- Extremely hygienic.

**BC-ACC-7410**

5x5x19,5cm 200ml  
 6 6 oil

**Mineral oil for maintenance bamboo & wooden boards 200ml**

- Protects bamboo from drying out and cracking.
- Odourless, tasteless and colourless.
- Only suitable for bamboo and wood.

**BC-ACC-7304**

45x35x5cm  
 3 1 bamboo

**Bamboo chopping block FSC® 45x35x5cm**

- Easy cutting & processing of ingredients.
- FSC®-labeled.
- Doesn't dull knives.
- Absorbs hardly any moisture, so doesn't deform.
- Extremely hygienic.

**BC-ACC-7305**

46,5x28x2,8cm  
 3 1 bamboo

**Bamboo cutting board with groove FSC® 46.5x28x2.8cm**

- Easy cutting & processing of ingredients.
- FSC®-labeled.
- With juice channel.
- Doesn't dull knives.
- Absorbs hardly any moisture, so doesn't deform.

**BC-SPA-8119**

0,1x31x20cm  
 12 1 stainless steel

**Ground grid in stainless steel ø 18cm**

- Suitable for the Barbecue Loewy, Arena, Major and Optima charcoal barbecue.

**BC-ACC-7458**

44x44x2cm  
 10 1 stainless steel

**Cooking grill ø 40cm**

- Suitable for the Barbecue Loewy 40 and Basic charcoal barbecue.
- Easy to clean.
- Suitable for preparing any preparation.

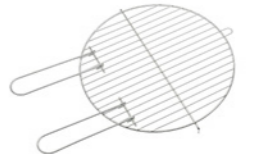
**BC-ACC-7306**

40x30x3cm  
 3 1 bamboo

**Bamboo cutting board with groove FSC® 40x30x3cm**

- Easy cutting & processing of ingredients.
- FSC®-labeled.
- With juice channel.
- Doesn't dull knives.
- Absorbs hardly any moisture, so doesn't deform.

**BC-ACC-7307**

50x35x3cm  
 3 1 bamboo

**Bamboo cutting board with groove FSC® 50x35x3cm**

- Easy cutting & processing of ingredients.
- FSC®-labeled.
- With juice channel.
- Doesn't dull knives.
- Absorbs hardly any moisture, so doesn't deform.

**BC-ACC-7461**

43x43x1cm  
 10 1 stainless steel

**Cooking grill ø 43cm**

- Suitable for the Barbecue Loewy 45 and Optima charcoal barbecue.
- Easy to clean.
- Suitable for preparing any preparation.

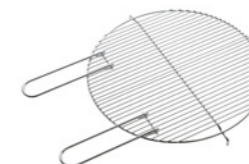
**BC-ACC-7459**

54x54x2cm  
 10 1 stainless steel

**Cooking grill ø 50cm**

- Suitable for the Barbecue Major and Loewy 50 charcoal barbecue.
- Easy to clean.
- Suitable for preparing any preparation.

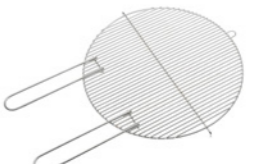

**BC-ACC-7460**

59,7x36,4x2 cm  
 10 1 stainless steel

**Cooking grill 55x33.6cm**

- Suitable for the Barbecue Loewy 55 and Arena charcoal barbecue.
- Easy to clean.
- Suitable for preparing any preparation.

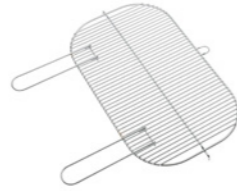
**BC-ACC-7158**

58,5x68x1 cm  
 6 1 chrome-plated steel,wood

**Professional cooking grill 58.5x40cm FSC®**

- Chromed grid.
- Can be shortened as desired.
- Easy to clean.
- FSC®-labeled.

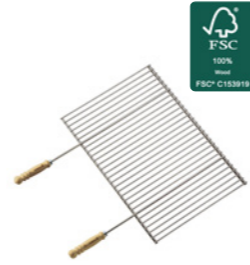
**BC-ACC-7159**

70x67x1 cm  
 6 1 chrome-plated steel,wood

**Professional cooking grill 70x40cm FSC®**

- Chromed grid.
- Can be shortened as desired.
- Easy to clean.
- FSC®-labeled.

**BC-ACC-7160**

90x67x1 cm  
 6 1 chrome-plated steel,wood

**Professional cooking grill 90x40cm FSC®**

- Chromed grid.
- Can be shortened as desired.
- Easy to clean.
- FSC®-labeled.

**BC-ACC-7223****NEW**

62x31x0,3 cm  
 6 1 stainless steel 304

**Cooking grill for fire pit 62cm**

- Preparing delicacies over the fire bowl.
- Semi-circular shape makes it easy to add extra wood.
- Compatible with the Jack 60 and Modern 60 fire bowls.

**BC-ACC-7224****NEW**

75x37,5x0,3 cm  
 6 1 stainless steel 304

**Cooking grill for fire pit 75cm**

- Preparing delicacies over the fire bowl.
- Semi-circular shape makes it easy to add extra wood.
- Compatible with the Jack 75 and Modern 75 fire bowls.

**BC-PLA-3010****NEW**

62x31x0,3 cm  
 6 1 carbon steel

**Carbon steel plancha 62cm**

- Preparing delicacies over the fire bowl.
- Semi-circular shape makes it easy to add extra wood.
- Compatible with the Jack 60 and Modern 60 fire bowls.
- Elegant design with engraved Barbecue logo.

**BC-PLA-3011****NEW**

75x32,5x0,3 cm  
 6 1 carbon steel

**Carbon steel plancha 75cm**

- Preparing delicacies over the fire bowl.
- Semi-circular shape makes it easy to add extra wood.
- Compatible with the Jack 75 and Modern 75 fire bowls.
- Elegant design with engraved Barbecue logo.

**BC-ACC-7446****NEW**

57x57x14,5 cm  
 6 1 steel

**Steel spark screen black 62cm**

- Protection against flying sparks.
- Safe use with family and kids.
- Compatible with the Jack 60 and Modern 60 fire bowls.

**BC-ACC-7447****NEW**

72x72x15 cm  
 6 1 steel

**Steel spark screen black 75cm**

- Protection against flying sparks.
- Safe use with family and kids.
- Compatible with the Jack 75 and Modern 75 fire bowls.

**BC-ACC-7107**

27x27x30 cm  
 6 1 lacquered steel

**Chestnut pan made of lacquered steel black**

- Can be used in conjunction with a fire pit or charcoal barbecue.
- Heat resistant paint up to 600°C.
- Extra long handle of 35 cm.
- The bottom of the pan has holes

**BC-WOO-6017**

60x60x1 cm  
 6 1 chrome-plated steel

**Junko grill chrome**

- Handy accessory for the Barbecue Junko.
- Easy to attach to the pulley of the Barbecue Junko.
- Equipped with raised edge.
- Easy to clean.
- Suitable for preparing any preparation.

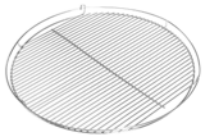
**BC-WOO-6002**

60x60x5 cm  
 4 1 enamelled steel

**Junko barbecue pan**

- Handy accessory for the Barbecue Junko.
- Easy to attach to the pulley of the Barbecue Junko.
- Ideal for pan dishes such as paella.

**BC-WOO-6006**

37x37x13 cm  
 2 1 enamelled cast iron

**Junko cast iron wok**

- Handy accessory for the Barbecue Junko.
- Easy to attach to the pulley of the Barbecue Junko.
- Made of enamelled cast iron.
- Easy to clean.

**BC-WOO-6009**

14x14x11 cm 700 ml  
 6 1 enamelled cast iron

**Junko cast iron Dutch Oven 0.7L**

- Handy accessory for the Barbecue Junko.
- Resistant to high temperatures.
- Holds heat for a long time thanks to cast iron.
- Easy to clean.

**BC-WOO-6008**

25x25x18,5 cm 3L  
 2 1 enamelled cast iron

**Junko cast iron Dutch Oven 3L**

- Handy accessory for the Barbecue Junko.
- Resistant to high temperatures.
- Holds heat for a long time thanks to cast iron.
- Easy to clean.





**BC-WOO-6007**

32x32x21 cm 9L  
 36 1 enamelled cast iron

**Junko cast iron Dutch Oven 9L**

- Handy accessory for the Barbecue Junko.
- Resistant to high temperatures.
- Holds heat for a long time thanks to cast iron.
- Easy to clean.

**BC-ACC-7453**

36x36x0,6 cm  
 0 1 carbon steel

**Dynamic Centre stand and elevated grill Ø 36cm for Nestor**

- 6 mm thick carbon steel.
- Grilling ingredients evenly.

**BC-ACC-7441**

51,7x51,7x16,5 cm  
 4 1 ceramic, stainless steel

**Kamal Large flexible cooking system**

- Possibility to place grid on 2 levels.
- Perfect heat distribution.
- Ideal for indirect grilling.

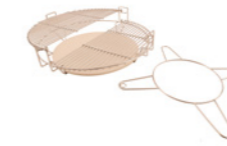
**BC-ACC-7442**

46x23x1,6 cm  
 5 1 cast iron

**Kamal Medium set of 2 half-moon cast iron grids**

- Grilling ingredients evenly.
- Made of cast-iron, therefore extremely qualitative.

**BC-ACC-7454**

36x36x0,8 cm  
 0 1 enamelled cast iron

**Dynamic Centre sear grate ø36cm for Nestor**

- Made of high-quality cast iron.
- Easy searing of ingredients.
- Compatible with the Dynamic Centre stand for Nestor.

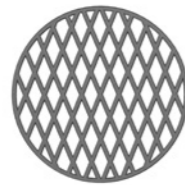
**BC-ACC-7455**

36x36x5 cm  
 0 1 carbon steel

**Dynamic Centre skewer holder Ø 36cm for Nestor**

- 3 mm thick carbon steel.
- For holding and grilling multiple skewers.
- Compatible with the Dynamic Centre stand for Nestor.

**BC-ACC-7443**

53x26,5x2,5 cm  
 5 1 cast iron

**Kamal Large set of 2 half-moon cast iron grids**

- Grilling ingredients evenly.
- Made of cast-iron, therefore extremely qualitative.

**BC-ACC-7118**

48x48x8,5 cm  
 2 1 ceramic, rubber wood

**Joya rubber wood rotating table with 6 bowls**

- Turntable with 6 stylish bowls made of ceramic.
- Suitable for the Barbecue Joya table barbecue.
- Easy to clean.

**BC-ACC-7456**

36x36x3,5 cm  
 0 1 steel

**Dynamic Centre wok & Dutch oven holder Ø 36cm for Nestor**

- 5 mm thick heat-resistant steel wire.
- For holding a Barbecue wok or Dutch Oven.
- Compatible with the Dynamic Centre stand for Nestor.

**BC-ACC-7450**

32x16,5x6 cm  
 0 1 stainless steel

**Coal trays for Magnus**

- 1 mm thick stainless steel.
- Creating different heat zones.
- Also ideal for placing the smoker box.

**BC-ACC-7096**

19x2x28 cm  
 20 1 aluminum, cotton

**Cotton glove red**

- Made of 100% cotton.
- Secure aluminum insulation on the inside of the glove.
- Protects your hands from the heat of your barbecue.

**BC-ACC-7099**

17x6,5x40 cm  
 6 1 aluminum, cotton

**Pair of long cotton gloves black**

- Made of 100% cotton.
- Secure aluminum insulation on the inside of gloves.
- Protects your hands from the heat of your barbecue.

**BC-ACC-7451**

67,5x43,5x18 cm  
 0 1 stainless steel

**Pizza oven for Magnus**

- Easy baking of pizza.
- To be used in combination with Barbecue's rectangular pizza plate.
- Very easy to attach and detach from Magnus.

**BC-ACC-7440**

47,5x47,3x14,8 cm  
 4 1 ceramic, stainless steel

**Kamal Medium flexible cooking system**

- Possibility to place grid on 2 levels.
- Perfect heat distribution.
- Ideal for indirect grilling.

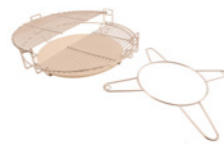
**BC-ACC-7100**

21,5x5x41 cm  
 6 1 aluminum, cotton

**Set with apron and long black gloves**

- Made of 100% cotton.
- Secure aluminum insulation on the inside of gloves.
- Protects your hands from the heat of your barbecue.

**BC-ACC-7052**

15x1x33 cm  
 6 1 aramid, cotton, polyester



**Premium pair of gloves black**

- Fireproof silicone strips.
- Provides protection up to 350°C.
- Suitable for providing grip.



**BC-ACC-7109**

 76x0,2x85 cm

 25  1  leather

**Leather apron brown**

- Made of cow leather.
- Protects your clothing from grease stains.
- Leather thickness: 1,4 - 1,6 mm.



# TASTE

barbecook

## BC-ACC-7217

9x9x20 cm 250g

12 1 spices

### Fire spices 250g

- Composition: herbs (parsley, rosemary, fenugreek, dill) spices (coriander), vegetable oil (rapeseed).
- Give extra flavor to your preparations.
- Give an aromatic smell.
- Add directly to the coals.



5 420059 844847

## BC-SMO-5007

19,5x8,5x26 cm 230g

6 6 beech

### Smoking dust beech

- For cold smoking only.
- 100% natural.
- Perfect with pork, chicken and fish.
- Most common wood for cold smoking.
- Mild smokey flavour that is easy to combine.



5 400269 207540

## BC-SMO-5008

19,5x8x26 cm 250g

6 6 alder

### Smoking dust alder

- For cold smoking only.
- 100% natural.
- Perfect with salmon or cheese.
- Mild, sweet and musky flavour.



5 400269 207557

## BC-SMO-5040

23x10x34 cm 700g

6 6 oak

### Smoking dust oak

- Adding a delicious smokey flavour to food.
- Ideal with meat, poultry, fish, vegetables, cheese.



5 420059 855959

## BC-SMO-5041

23x10x34 cm 700g

6 6 oak

### Smoking dust oak whiskey

- Adding a delicious smokey flavour to food.
- Ideal with beef, lamb, pork, chicken, vegetables, cheese.



5 420059 855966

## BC-SMO-5042

23x10x34 cm 700g

6 6 oak

### Smoking dust oak red wine

- Adding a delicious smokey flavour to food.
- Ideal with red meat, game, pork, fish.



5 420059 855973

**BC-SMO-5043**

23x10x34 cm 700g  
 6 6 olive wood

**Smoking dust olive**

- Adding a delicious smokey flavour to food.
- Ideal with poultry.

**BC-SMO-5000**

18x7,5x25 cm 310g  
 6 6 apple wood

**Smoking chips apple**

- 100% natural.
- Perfect with beef, poultry and ham.
- Sweet and fruity smokey flavour.

**BC-SMO-5031**

23x10x34 cm 600g  
 6 6 oak

**Smoking chips oak whiskey**

- Adding a delicious smokey flavour to food.
- Flavour of oak & whiskey.
- Ideal with beef, lamb, pork, chicken, vegetables, cheese.

**BC-SMO-5032**

23x10x34 cm 600g  
 6 6 oak

**Smoking chips oak red wine**

- Adding a delicious smokey flavour to food.
- Sweet & spicy flavour.
- Ideal with red meat, game, pork, fish.

**BC-SMO-5001**

18x7,5x25 cm 330g  
 6 6 oak

**Smoking chips oak**

- 100% natural.
- Perfect with red meat, fish, game and spareribs.
- Mild flavour.
- most versatile smoker chip.

**BC-SMO-5002**

18x7,5x25 cm 310g  
 6 6 hickory

**Smoking chips hickory**

- 100% natural.
- Ideal with meat, poultry & pork.
- Authentic flavour.
- Strong flavour, usually mixed with oak for a perfect balance (1/3 hickory, 2/3 oak).

**BC-SMO-5033**

23x10x34 cm 600g  
 6 6 oak

**Smoking chips oak cognac**

- Adding a delicious smokey flavour to food.
- Strong, robust taste.
- Ideal with red meat, game.

**BC-SMO-5009**

19,5x8,5x26 cm 375g  
 6 6 oak

**Wood chunks red wine**

- 100% natural.
- Perfect with red meat and poultry.
- Gives a mild smokey flavour.

**BC-SMO-5003**

19,5x9x25 cm 350g  
 6 6 olive wood

**Smoking chips olive**

- 100% natural.
- Perfect with poultry.
- Gives a mediterranean flavour.

**BC-SMO-5004**

19,5x9x26 cm 350g  
 6 6 cherry wood

**Smoking chips cherry**

- 100% natural.
- Perfect with poultry, pork, beef and ham.
- Sweet and fruity smokey flavour.

**BC-SMO-5010**

19,5x8,5x26 cm 350g  
 6 6 beech

**Wood chunks beech**

- 100% natural.
- Ideal with meat, poultry, fish, vegetables, cheese.
- Mild smokey flavour that is easy to combine.
- Most commonly wood for smoking.

**BC-SMO-5050**

23x10x34 cm 900g  
 6 6 oak

**Wood chunks oak whiskey**

- Adding a delicious smokey flavour to food.
- Ideal with beef, lamb, pork, chicken, vegetables, cheese.

**BC-SMO-5005**

19,5x9x26 cm 375g  
 6 6 lemon wood

**Smoking chips lemon**

- 100% natural.
- Perfect with poultry, white fish and seafood.
- Dominant citrus smoke with a mild fruity flavour.

**BC-SMO-5030**

23x10x34 cm 600g  
 6 6 oak

**Smoking chips oak**

- Adding a delicious smokey flavour to food.
- All-rounder, slightly more pronounced flavour, but still quite mild.
- Can be mixed with other types if necessary.
- Ideal with meat, poultry, fish, vegetables and cheese.

**BC-SMO-5051**

23x10x34 cm 900g  
 6 6 oak

**Wood chunks oak cognac**

- Adding a delicious smokey flavour to food.
- Ideal with red meat, game.

**BC-SMO-5052**

23x10x34 cm 900g  
 6 6 peach wood

**Wood chunks peach**

- Adding a delicious smokey flavour to food.
- Ideal with poultry, pork.



**BC-SMO-5053**

23x10x34cm 900g  
 6 6 oak

**Wood chunks oak**

- Adding a delicious smokey flavour to food.
- Ideal with meat, poultry, fish, vegetables, cheese.

**BC-SMO-7430**

23,5x18,5x24,5cm 1,5kg  
 150 1 alder

**Bucket with smoking dust alder**

- Adding a delicious smokey flavour to food.
- Sweet flavour and musky aroma.
- Ideal with poultry, pork and fish.

**BC-SMO-7437**

23,5x18,5x24,5cm 2kg  
 0 1 oak

**Bucket with smoking chips oak whiskey**

- Adding a delicious smokey flavour to food.
- Flavour of oak and whiskey.
- Ideal with beef, lamb, pork, chicken, vegetables and cheese.

**BC-SMO-5060**

7x17x8,8cm 150g  
 6 6 aluminum,oak

**3 kinds of smoking chips oak, whiskey and red wine**

- Adding a delicious smokey flavour to food.
- In aluminium trays.
- Heat resistant up to 450 °C.

**BC-SMO-7431**

23,5x18,5x24,5cm 2,5kg  
 0 1 olive wood

**Bucket with smoking dust olive**

- Adding a delicious smokey flavour to food.
- Spicy and earthy flavour.
- Can be mixed with oak or hickory.
- Ideal with poultry.

**BC-SMO-7432**

23,5x18,5x24,5cm 2,5kg  
 150 1 oak

**Bucket with smoking dust oak**

- Adding a delicious smokey flavour to food.
- All-rounder, slightly more pronounced flavour, but still quite mild.
- Can be mixed with other types if necessary.
- Ideal with meat, poultry, fish, vegetables and cheese.

**BC-SMO-5011**

30x14x0,4cm  
 12 1 cedar

**Set of 2 smoking planks cedar wood**

- For a mild smokey flavor.
- Suitable for salmon, seafood, beef and pork.
- Set of 2 smoking planks.

**BC-SMO-5012**

30x14x0,4cm  
 12 1 beech

**Set of 2 smoking planks beech wood**

- For a mild smokey flavor.
- Suitable for salmon, seafood, beef and pork.
- Set of 2 smoking planks.

**BC-SMO-7433**

23,5x18,5x24,5cm 2,5kg  
 0 1 oak

**Bucket with smoking dust oak whiskey**

- Adding a delicious smokey flavour to food.
- Flavour of oak and whiskey.
- Ideal with beef, lamb, pork, chicken, vegetables and cheese.

**BC-SMO-7434**

23,5x18,5x24,5cm 1,3kg  
 0 1 alder

**Bucket with smoking chips alder**

- Adding a delicious smokey flavour to food..
- Sweet flavour, musky aroma.
- Ideal with poultry, pork, fish.

**BC-SMO-5013**

30x14x0,4cm  
 12 1 alder

**Set of 2 smoking planks alder wood**

- For a mild smokey flavor.
- Suitable for salmon, seafood, beef and pork.
- Set of 2 smoking planks.

**BC-SMO-5019**

9,5x4x23,2cm  
 6 1 enamelled steel,stainless steel

**Smoker box**

- Stainless cover.
- Fits in all Barbecook gas barbecues.
- Without holder also suitable on other devices.

**BC-SMO-7435**

23,5x18,5x24,5cm 2kg  
 0 1 olive wood

**Bucket with smoking chips olive**

- Adding a delicious smokey flavour to food.
- Spicy and earthy flavour.
- Can be mixed with oak or hickory.
- Ideal with poultry.

**BC-SMO-7436**

23,5x18,5x24,5cm 2kg  
 0 1 oak

**Bucket with smoking chips oak**

- Adding a delicious smokey flavour to food.
- All-rounder, slightly more pronounced flavour, but still quite mild.
- Can be mixed with other types if necessary.
- Ideal with meat, poultry, fish, vegetables and cheese.

**BC-SMO-5021**

18x18x5cm  
 6 1 stainless steel,steel

**Cold smoke generator**

- Ideal for cold smoking between 20-25°C.
- Cold smoking for up to 13 hours.
- Easy to fill with smoke dust.

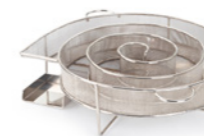
**BC-SMO-7422**

20,5x17x4,5cm 360g  
 6 1 nickel,steel

**Cold smoker starter set**

- Cold smoking of ingredients in a smoker or barbecue with lid.
- Can smoke up to 13 hours.
- Easy to fill with smoking dust.
- The set contains a generator for cold smoking and 3 different kinds of smoking dust: olive, whiskey, oak.
- Including booklet with recipes.





# CARE

barbecook

## BC-ACC-7039

6,8x3,5x42,5 cm  
8 1 glass fiber, nylon, stainless steel

- Olivia stainless steel cleaning brush**
- Suitable for cleaning your barbecue grid.
  - Convenient storage with hanging loop.



## BC-ACC-7040

14,3x3x43 cm  
8 1 glass fiber, nylon, stainless steel

- Olivia stainless steel spiral brush**
- Suitable for cleaning your barbecue grid.
  - Convenient storage with hanging loop.



## BC-ACC-7051

13x8x8 cm  
8 1 palmyra fiber, polypropylene

- Olivia Premium cleaning brush with palm hair**
- Suitable for cleaning your barbecue grid.
  - Resistant to intense heat.
  - Ergonomic handle.
  - Made of palm hair.



## BC-ACC-7064

15x6x11 cm  
24 24 brass, polyester, polypropylene, Stainless steel 340

- 3-in-1 brush red**
- Suitable for cleaning your barbecue grid.
  - Compact brush.
  - 3 functions: brushing, sanding and scraping.



## BC-ACC-7065

3,5x2x42 cm  
12 1 brass, polyester, polypropylene, Stainless steel 340

- 3-in-1 long brush black**
- Suitable for cleaning your barbecue grill.
  - 3 functions: brushing, sanding and scraping.



## BC-ACC-7067

17x3x52 cm  
6 1 brass, polypropylene

- Long spiral brush black**
- Suitable for cleaning your barbecue grill.
  - Suitable for cleaning hard-to-reach areas.



## BC-ACC-7074

7x3x31 cm  
12 1 brass, leather, rubber wood, stainless steel

- Copper and steel brush FSC®**
- Suitable for cleaning your barbecue grid.
  - Rubber wood handle and stainless steel scraper.
  - FSC®-labeled.



## BC-ACC-7027

6x3x38 cm  
6 1 ABS, stainless steel, TPR

- Army Style cleaning brush with dual function**
- Khaki green handle.
  - Suitable for cleaning your barbecue grid.
  - 2 functions: brushing and scraping.
  - Easy to clean.
  - Made of stainless steel.



## BC-ACC-7058

15x9x6 cm  
24 1 dacron, polypropylene

- Cleaning brush**
- Suitable for cleaning your barbecue grid.
  - Ergonomic plastic handle.



## BC-ACC-7063

4,5x2x23 cm  
24 1 brass, leather, rubber wood

- Two-headed grill brush FSC®**
- Suitable for cleaning your barbecue grid.
  - Made of copper and rubber wood.
  - FSC®-labeled.



## BC-ACC-7216

15x5x8 cm  
0 1 pumice

- Grill cleaner**
- Suitable for cleaning your barbecue grill.
  - Volcanic stone.
  - Removes residue on your barbecue grill quickly and thoroughly.



## BC-ACC-7179

65x65x60 cm  
12 1 PVC

- Charcoal barbecue transparent cover**
- Suitable for all the Barbecook charcoal barbecues.
  - Transparent cover.
  - Protects your charcoal barbecue.



## BC-ACC-7170

66x66x67 cm  
6 1 polyester

- Premium barbecue cover**
- Suitable for the Barbecook Loewy 40/45/50/50 SST, The Adam 50/Adam 50 Top and the Oskar S/M.
  - Protects your charcoal barbecue.
  - Soft and tear resistant polyester.
  - Water repellent and breathable.
  - UV-resistant.



## BC-ACC-7174

90x55x80 cm  
6 1 polyester

- Premium barbecue cover**
- Suitable for the Barbecook Spring 2002 and the Barbecook Alexia 5011/5111.
  - Protects your barbecue.
  - Soft and tear resistant polyester.
  - Water repellent and breathable.
  - UV-resistant.



**BC-ACC-7176**

120x55x95 cm

6 1 polyester

**Premium barbecue cover**

- Suitable for the Siesta 210.
- Protects your gas barbecue.
- Soft and tear resistant polyester.
- Water repellent and breathable.
- UV-resistant.

**BC-ACC-7172**

151x56,5x107 cm

6 1 polyester

**Premium barbecue cover**

- Suitable for the Barbecue Spring 3002/3112/3212, Siesta 310/412/612 and Stella 3021/3221/4311.
- Protects your gas barbecue.
- Soft and tear resistant polyester.
- Water repellent and breathable.
- UV-resistant.

**BC-ACC-7414**

66x66x85 cm

6 1 polyester,PVB

**Premium cover for Edson**

- Optimal protection for Edson barbecue.
- Water repellent.
- Breathable fabric.
- UV resistant.
- With drawstring to tighten.

**BC-ACC-7445**

82,5x82,5x90,1 cm

6 1 PVB

**Premium cover for Kamal**

- Optimal protection for Kamal kamado.
- Water repellent.
- Breathable fabric.
- UV-resistant.
- With cord to tighten.

**BC-ACC-7457**

93x81x2,5 cm

0 1 stainless steel 430

**Cover plate for Nestor**

- Optimal protection for the Nestor's grilling surface.

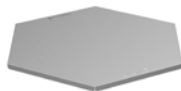
**NEW****BC-ACC-7050**

120x0,2x80 cm

12 1 polyethylene

**Plastic floor mat black**

- Protects the surface from dirt and grease.
- Easy to clean.
- Non-slip.
- Not heat resistant.

**BC-ACC-7444**

95x95x0,3 cm

0 9 PES,cork,rubber

**Floor matt anthracite**

- Fire & stain protection.
- Fire-contracting.
- Very flat so no risk of tripping.

**BC-ACC-7210**

8,5x6,5x25,2 cm

0 1

**Barbecue cleaning foam 500ml**

- Suitable for cleaning the barbecue and barbecue grids.
- Helps to degrease.

**NEW**

# GENERAL TERMS AND CONDITIONS

## **ORDER**

Minimum order value of €1.000.

## **DELIVERY TERMS**

Standard ex works Deinze (Belgium), unless specifically agreed otherwise.

## **PAYMENT CONDITIONS**

ING: IBAN: BE77 3701 1576 5042 / BIC: BBRUBEBB  
Payment in advance.

## **GUARANTEE**

In accordance with European guarantee conditions.

Barbecook® products have minimum a two-year guarantee against any manufacturing defects, valid from the date of purchase and to the extent that the product was used in accordance with the instructions. The receipt or invoice stating the date of purchase counts as the guarantee certificate. This guarantee is limited to the repair or replacement of parts showing defects under normal use.





**LIVWISE**

Vaartlaan 9  
9800 Deinze - Belgium  
T. +32 (0)9 385 93 24  
F. +32 (0)9 385 93 25  
info@livwise.be

BTW/TVA: BE 0454.468.358  
ING: IBAN: BE77 3701 1576 5042  
BIC: BBRUBEBB

[WWW.LIVWISE.BE](http://WWW.LIVWISE.BE)  
[WWW.BARBECOOK.COM](http://WWW.BARBECOOK.COM)

barbecue